

KORTA

GENERAL CATALOGUE

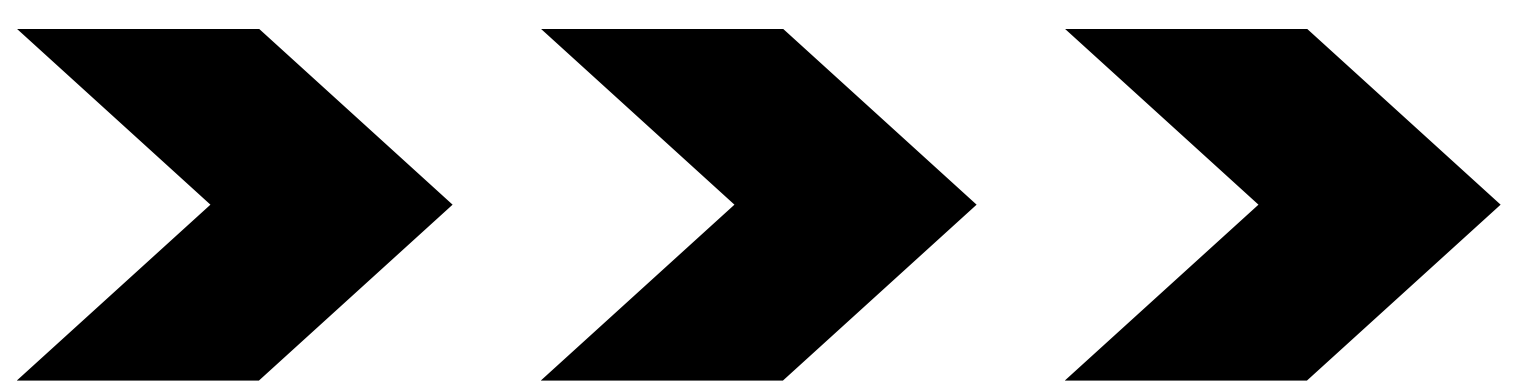

Discover our world of KORTA products.



*"This catalogue is about a hedonistic adventure we want
to take you to."*

*"We only design and create products that we enjoy
ourselves."*

Stefano Ladavac
Co-founder & CEO

KORTA

Inspiration

Istria 7

Natural stone 10

Who we are

Our philosophy 13

KORTA 19

The story

History 21

Timeline 23

Production

Hand-made 29

Premium Technology 31





Outdoor Relaxation Zones 34

Aqua Zone 35

Marbella 37

Odino 59

Minimo 73

Minno 85

Kada 97

Fuoco Zone 106

Gardenzio 107

Kamin 123

Aria Zone 130

Ponte 131

Dipinto 135

Cara 140

Designer's hub 145

Specification sheets 150

Codes & Production time 155

Certificates 157

Other materials 161

ISTRIA

Every now and then, life surprises us by reminding us how beautiful it can be. Rich in colors and excitement, full of joy and delight, very simple, cheerful. Sometimes we experience that moment while grilling with friends, in an evening walk with the person we love, with the smell of morning coffee...

But what if we told you that this is not about the moment at all, but about the place? About the place where you are always at your best. The place that invites you to be spontaneous, daring, and smiling. The place where you feel life as it should be. That place is called Istria.

The place that inspires us.

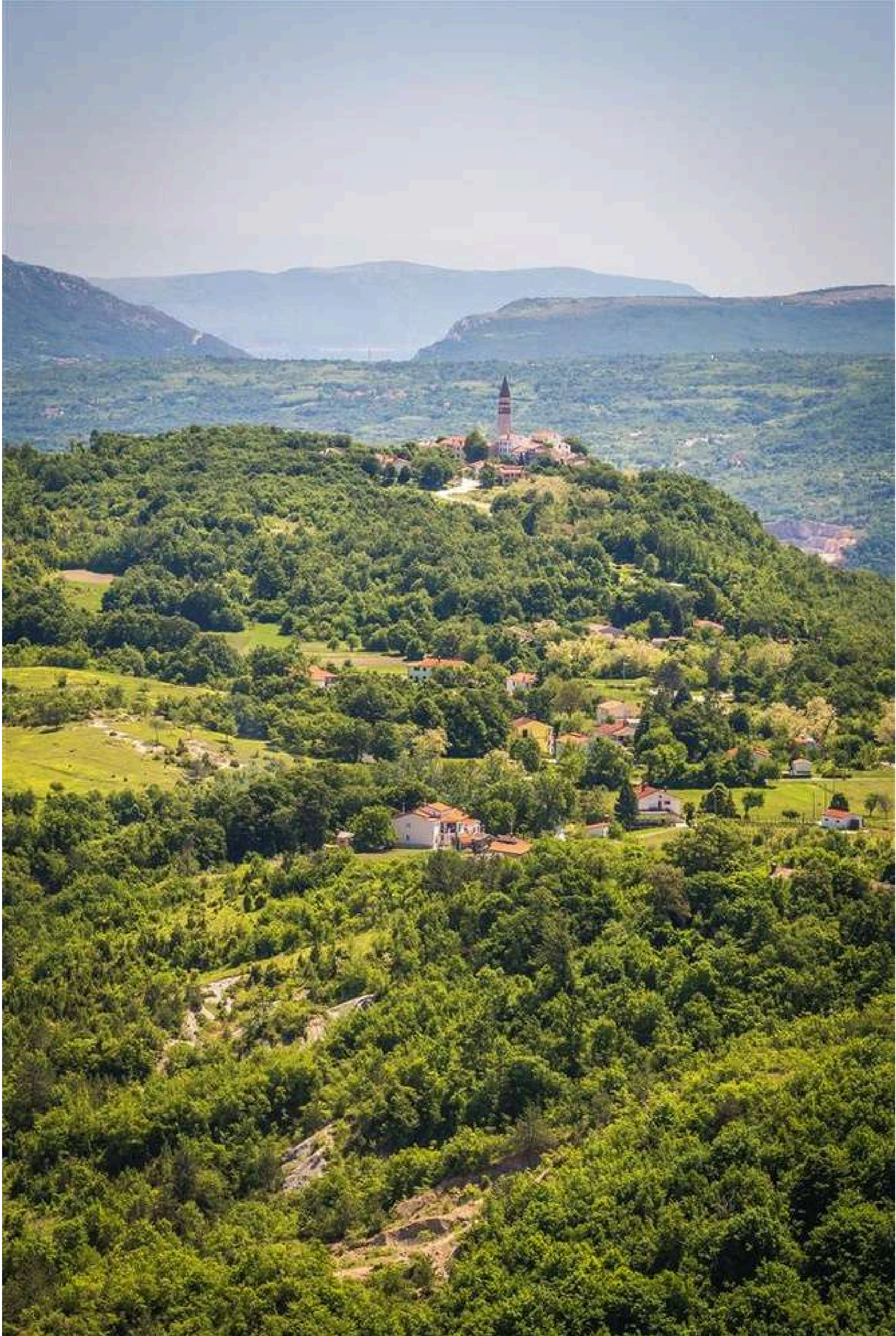



NATURAL STONE

Drawing inspiration from the materials that surround us and guided by the wisdom and expertise of our ancestors in stone craftsmanship, we embarked on our journey with the Istrian stone at its heart. The very quarries that once provided stone for the construction of Venetian architecture continue to be the source of our materials today.

We always choose materials that share the same characteristics: durability, quality, and beauty. Natural stone has excellent technical and mechanical properties in terms of absorption, freezing, and wear. It is incredibly durable and available in various finishes: polished, sandblasted, burnt or rigatto.

The inspiration, the material.





OUR PHILOSOPHY

Istria, our home and creative haven, still preserves the Italian tradition and heritage of enjoying the lifestyle of outdoor living. This is enabled by its splendid climate, landscape, architecture, and enveloping materials. Our mission is to elevate this heritage by bringing joy to you through our products.

We craft distinctive environments worldwide. Our brand mirrors an elegantly casual lifestyle, offering products that cater to both mind and body for relaxation—a key to our well-being. This equilibrium is achieved through designs that blend comfort, quality, and aesthetic pleasure, always tailored to the unique needs of our clients.

At KORTA our mission has always been to encourage people to sense harmony at home and wherever they are. This approach resonates with both hospitality and wellness projects. Our general desire is that each outdoor living space becomes an experience of the Istrian lifestyle.

Our doors open to stunning exteriors, where products harmonize with nature to establish the desired ambiance. This encapsulates our essence: fashioning environments where life can be embraced, lived, and enriched with hedonistic sensations.

Timeless Beauty, Carved in Stone. A Piece of Istria, to Call Your Own.



Mediterranean roots, passion for life, sun, and beautiful design.

At KORTA, we transcend mere shape and aesthetics, prioritizing the dynamics of interactions that unfold among humans, objects, and spaces.

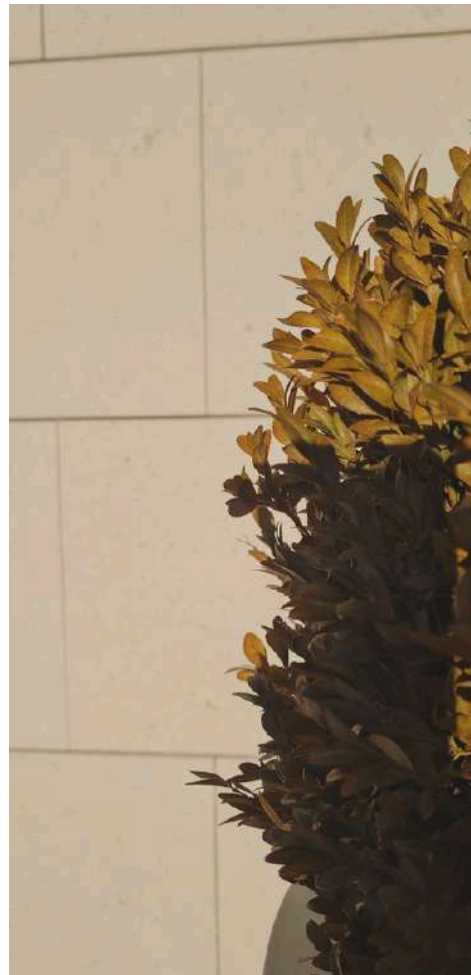

KORTA reveals hidden spaces, experiences, materials, and processes within everyday life.

We challenge ecological values and explore the perceptual and emotional experiences that the distinctive materiality of products can offer.

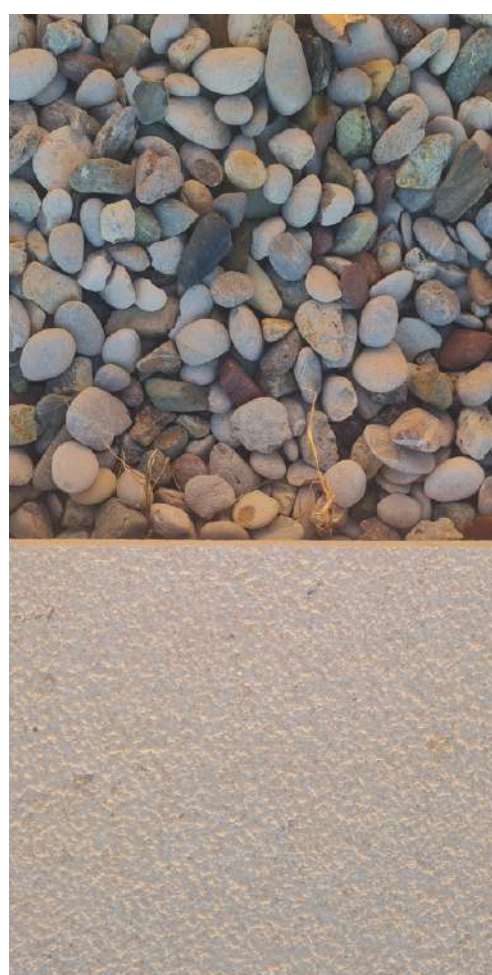



Our design charrettes, where multiple participants meet to exchange ideas and brainstorm solutions, stand as an example of transparency, and collaboration.

We encourage all our team members to be active participants in the design process, contributing ideas and suggestions for new product development.



We consistently look forward, assessing processes and outcomes that are both dependable and essential for a better future, while also becoming agents of tradition and transformation.



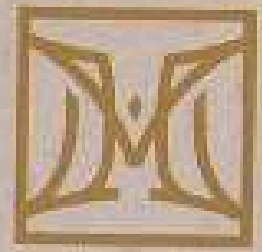

MAIORA

CHAMPÉ / IGUAZÚ / BUENOS AIRES

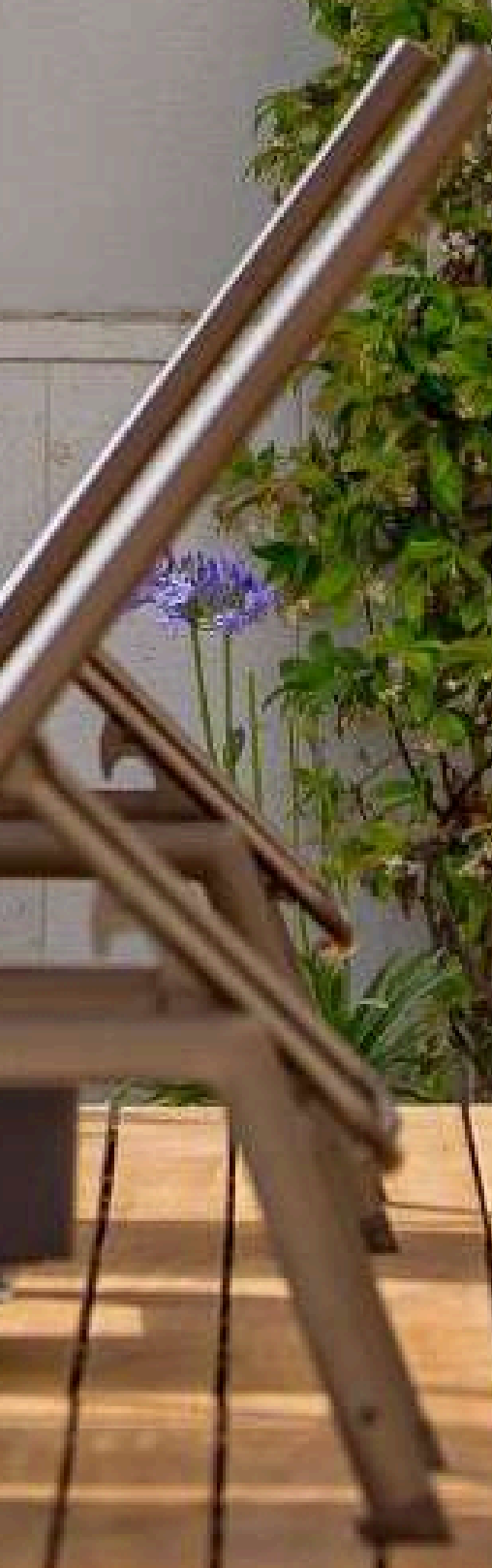

KORTA

kôrta f <G pl kôrâta/-i>

DEFINITION

a fenced outdoor area, backyard or patio

ETYMOLOGY

ital. corte

KORTA is based on the Mediterranean heritage of joy of outdoor living and aims to spread this lifestyle worldwide. Korta is a place of gathering and celebrating special moments, and a place to relax. We believe that everyone in the world deserves a *korta* filled with products with which they will feel comfortable and connected to.

We want to create a place for you where you can unwind, where you can feel the sun and get a sense of the Istrian lifestyle. Can you imagine the value of an hour of relaxation in your backyard? We make our products for these precious moments. There are unlimited possibilities and finishes for every style in the selection of our products and accessories.



The freedom to be yourself.

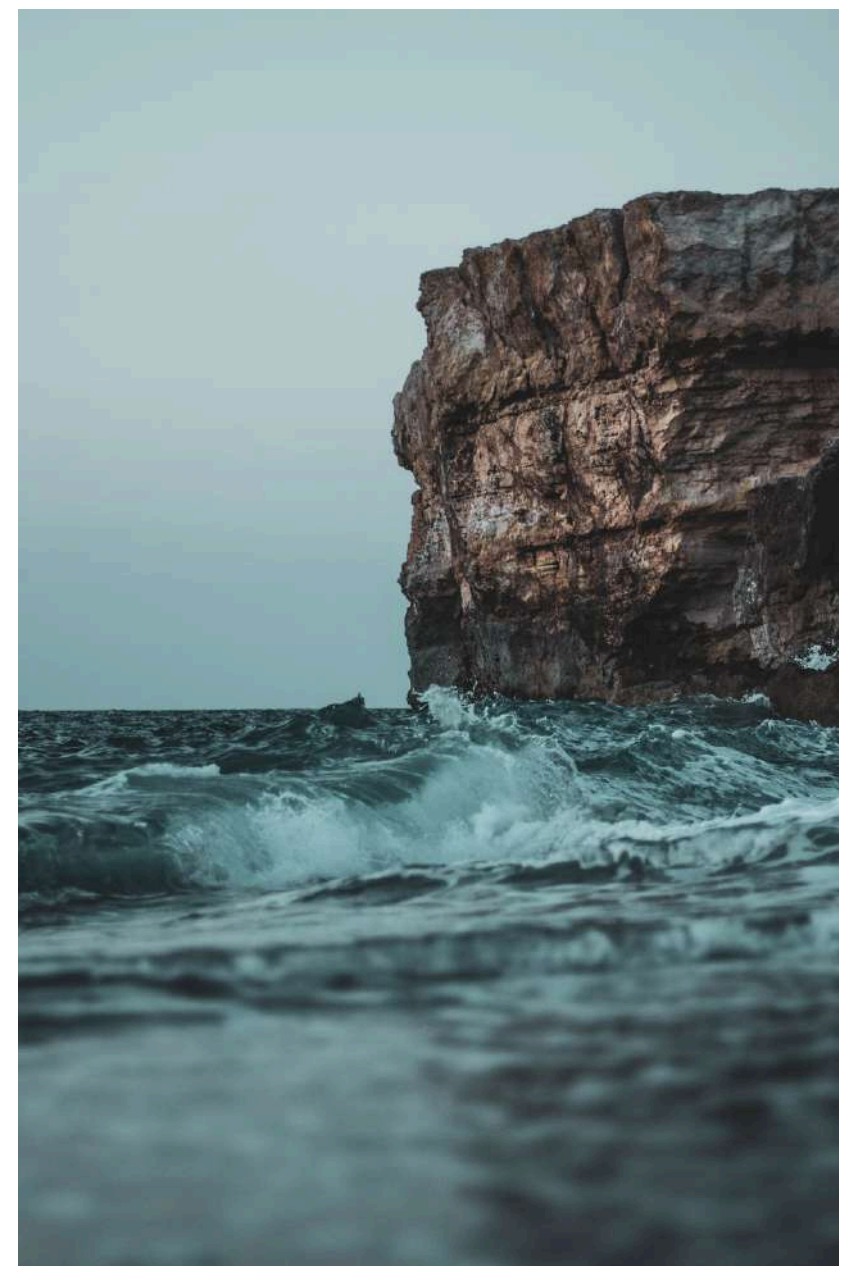
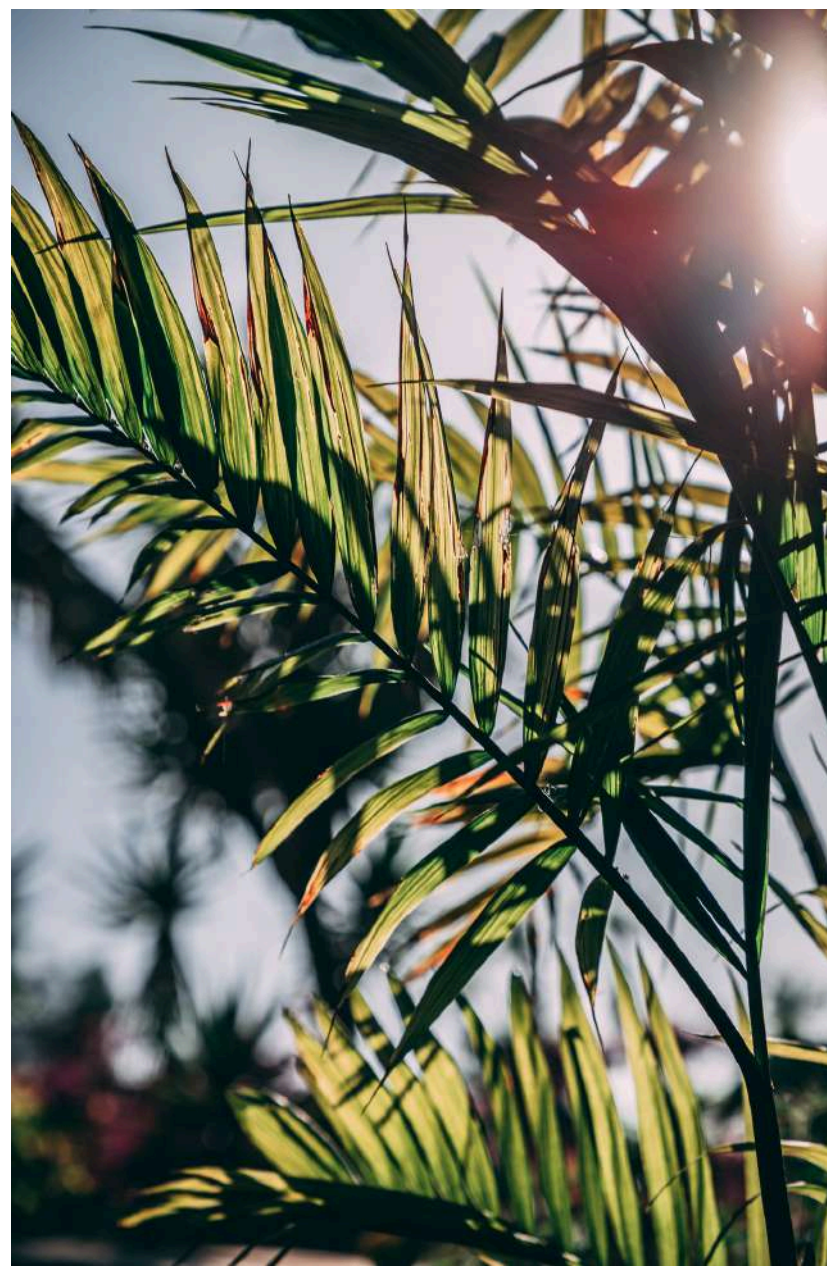
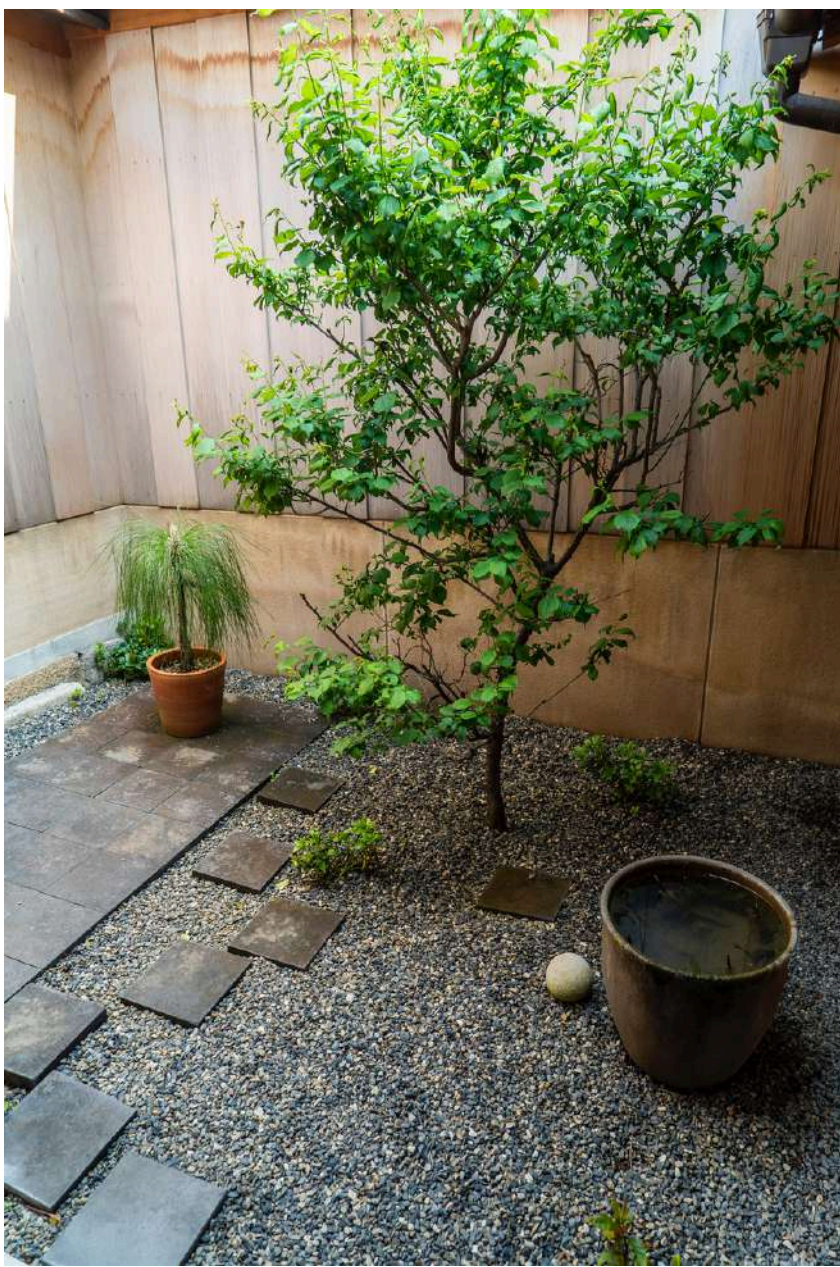

We established an international reputation for designing meaningful and inspiring products that connect people to a place, elevate the human experience, strengthen the spirit of community, and exceed expectations. Since our beginnings, we prioritized staying true to our values to create a strong sense of a product that resonates with nature, humans, and places on an emotional level.



THE STORY



Legacy.



Working with stone and similar materials is in the family's blood. Our legacy traces to 1995 when Stefano's grandfather and father started a business of natural stone processing. Their experience has been transferred to him, and he used it to create the first outdoor shower made of stone. His father is still active and now serves as our manufacturing advisor. We believe that it is crucial to have someone with experience on board.

We always deliver products of the very best quality. All our products are carefully engineered, manufactured, and internally tested; ensuring that they abide by our high standards of quality and performance. All of that to deliver the very best solutions to our clients. Most of our products are designed in-house, while Sandro Užila, a designer with whom we share the same values and philosophy, is the creator of particular design collections.

Heritage.

1995.

Franko and Sandro Ladavac opened their small craft for the production and stone processing.

2018.

The first shower was sold, and the customer was Dejan Lovren - a Croatian national football team player.

2017.

Stefano Ladavac founded Infinity Luxury d.o.o. and made the first outdoor shower made of stone.

2019.

Miloš Jarić joined the company as an investor. We completed the first project co-financed by EU funds to the amount of € 200,000.

2022.

We created KORTA, our new brand which brings it all together: our place, our legacy, our material, and who we are.

2021.

Marko & Nikola Jurman became partners and invested in the company to develop a world-known brand.

2023.

KORTA's brand can be found across 35 countries in the world: USA, Middle East and Europe

*What truly motivates me in my
work is witnessing the
acceptance of my ideas, their
feasibility in implementation,
and their tangible contributions
to concrete results.*

Jasmina Čerina

*Business Development
Manager for Spain & Portugal*





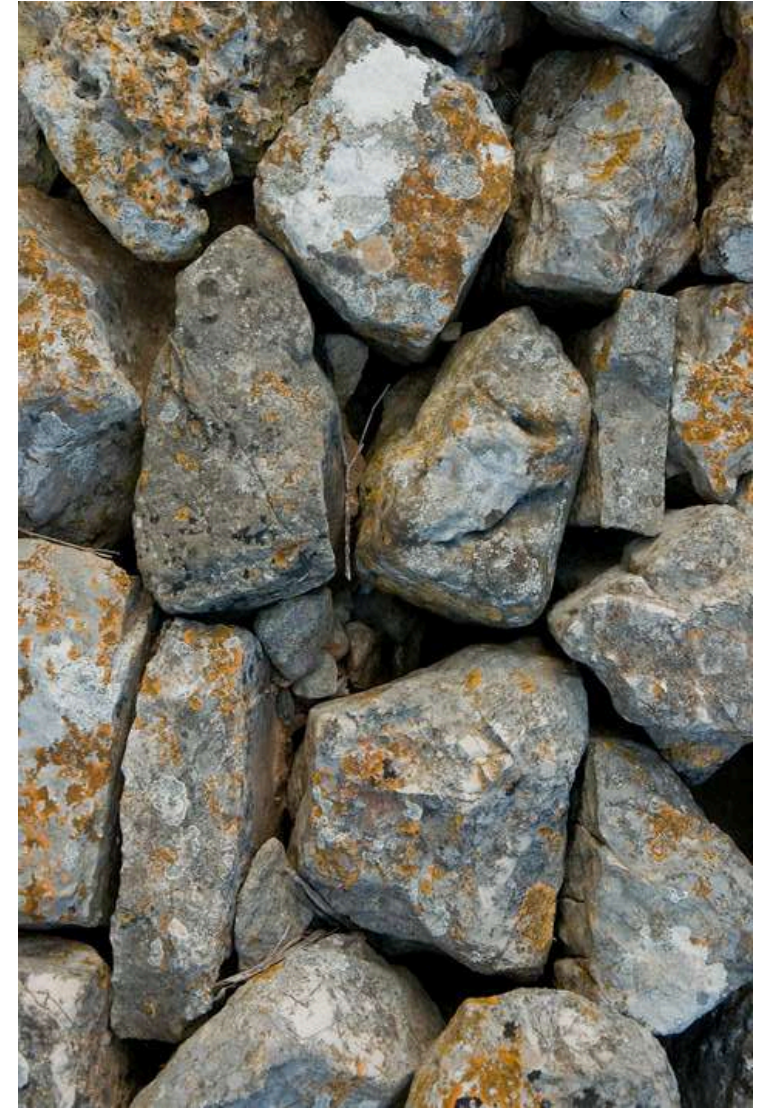

HAND-MADE

Our strength lies in the ability to delight others with our uniqueness and the courage in engaging in hands-on craftsmanship, all while remaining open to new, better ways that enhance our work. We enjoy playing with robust materials, elegant proportions, and unparalleled comfort, drawing inspiration from nature's finest and purest elements and carefully detailing harmonious shapes.

Manual processing allows us to invest ourselves in every intricately crafted piece. Thanks to the final hand-finish, each product delivered to the client emerges as a personalized, one-of-a-kind creation.





Location: KORTA production facility
Product: ODINO outdoor shower

Material: Marazzi Porcelain slabs

Touch of passion.

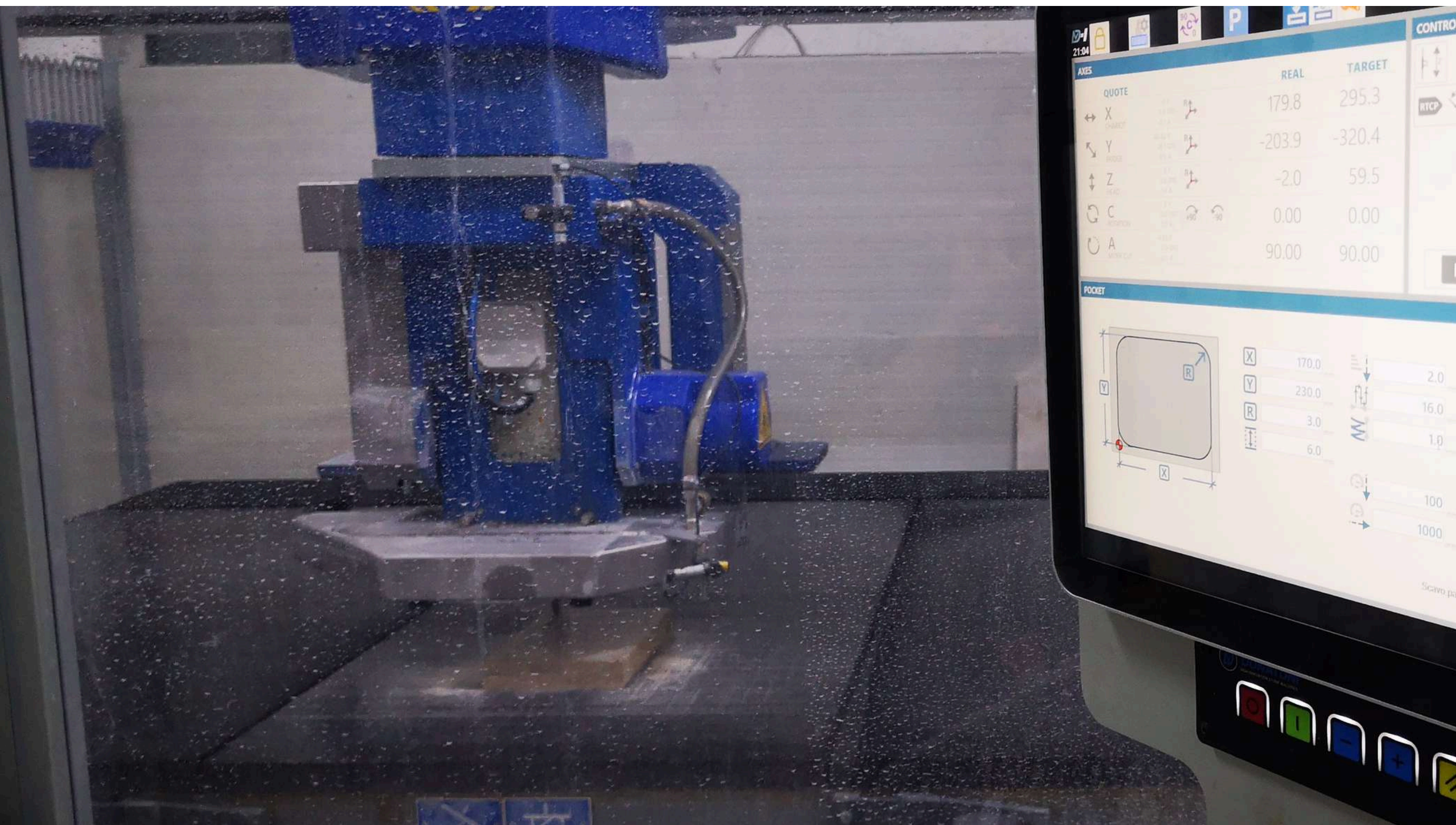

Manufacturer: Donatoni Macchine
Perfect for: marble and porcelain cutting

Machine: CNC 625 JET

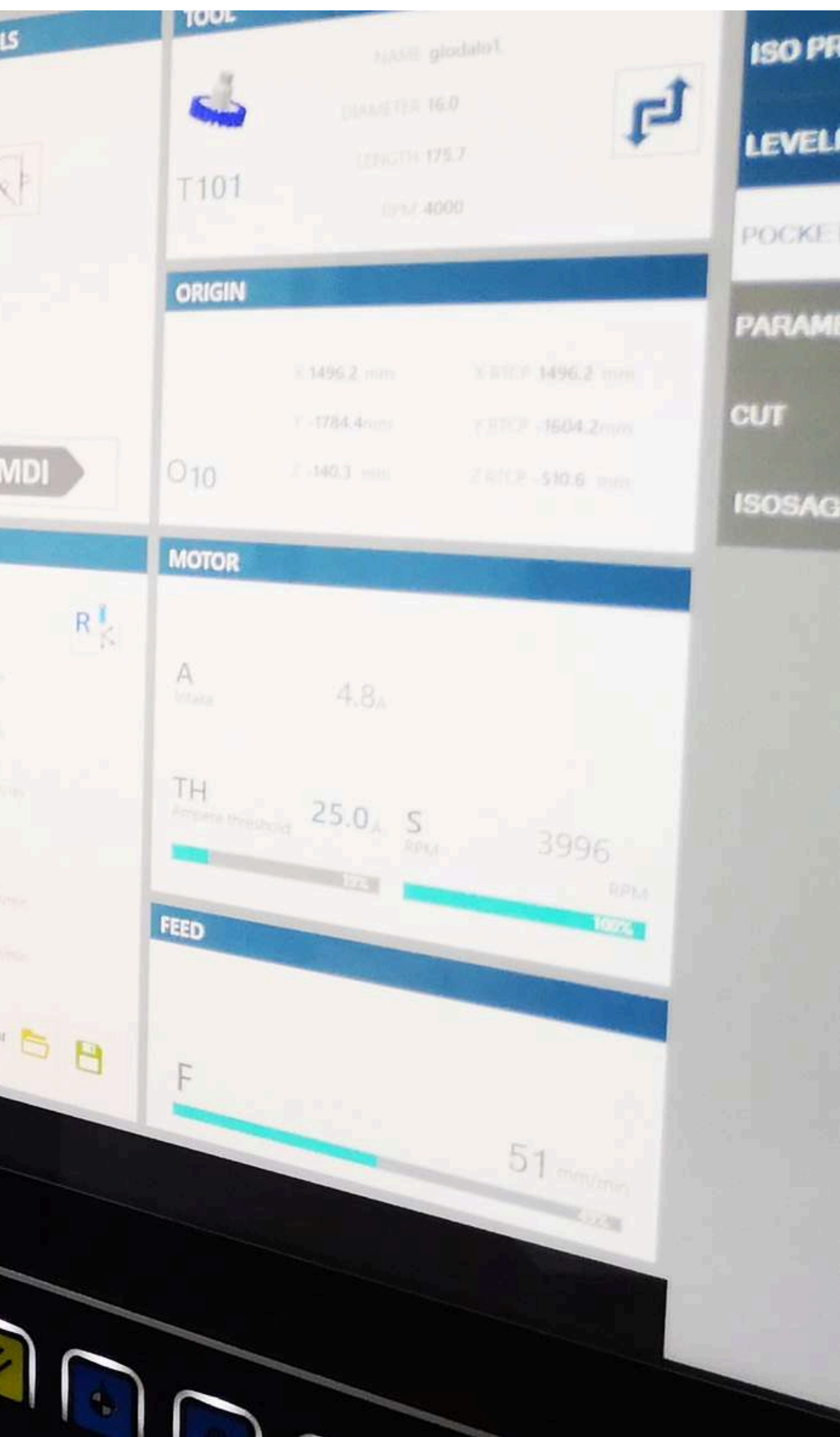

PREMIUM TECHNOLOGY





Resonate with nature, humans, and places.



OUTDOOR
RELAXATION ZONES



At KORTA, we believe that outdoor spaces should be designed to provide a sense of tranquility, comfort, and rejuvenation. With this philosophy in mind, we have developed an innovative concept of Outdoor Relaxation Zones, which are centered around three essential elements of life: water, fire, and air. The Aqua, Fuoco, and Aria zones are designed to transform any outdoor space into a haven of relaxation.

Whether you want to unwind by the tranquil sound of water, gather around a cozy fire pit with loved ones, or take in the fresh outdoor air, our Relaxation Zones offer the perfect solution. With KORTA's Outdoor Relaxation Zones, you can create a space that perfectly suits your relaxation needs, and allows you to fully enjoy your outdoor living experience.

AQUA ZONE

The Aqua Zone provides a revitalizing retreat from everyday life. Tailored to harness the revitalizing effects of water, this area presents an assortment of amenities that enable you to relish the calming advantages of indoor surroundings whilst enjoying the serene allure of the outdoor environment. Whether you seek rest from the sun or merely desire a haven to decompress and de-stress, the Aqua Zone serves as an ideal sanctuary.

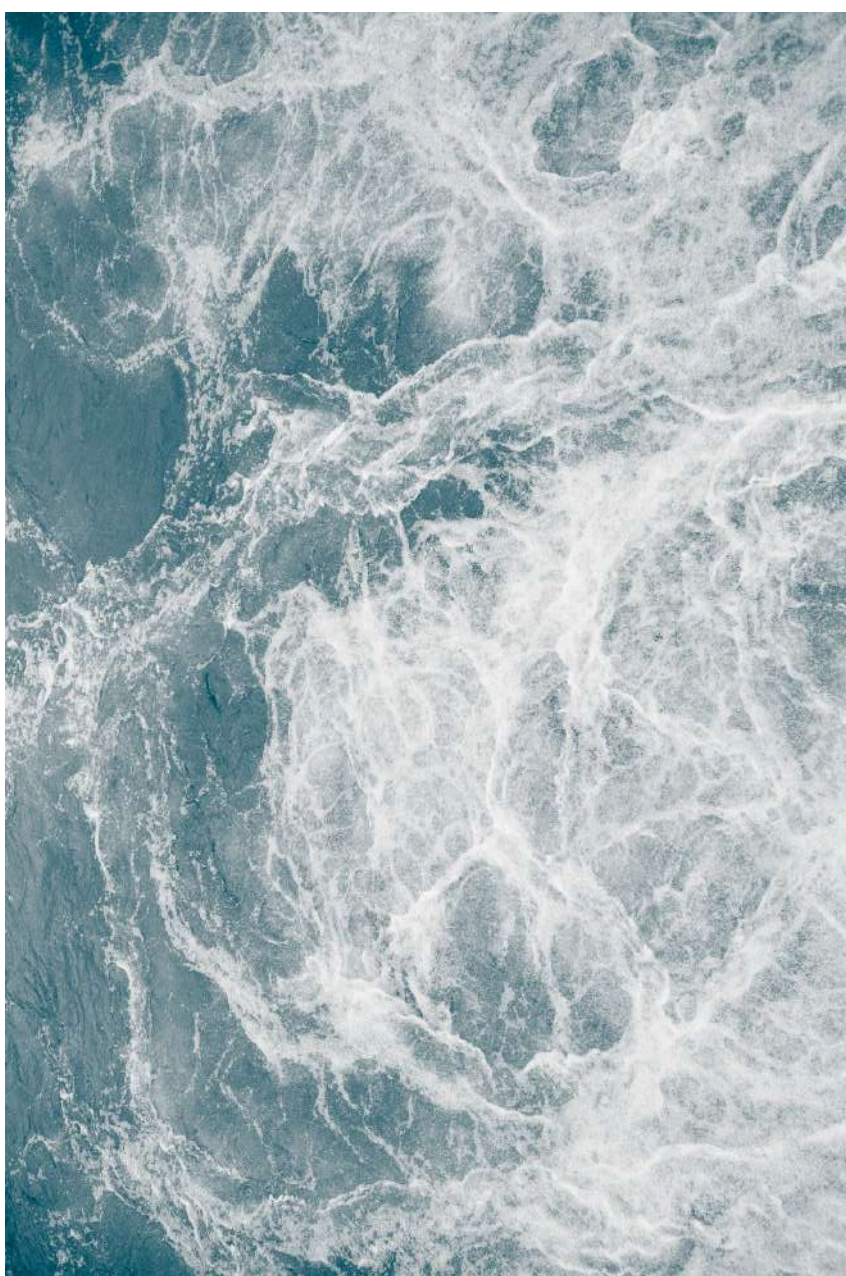
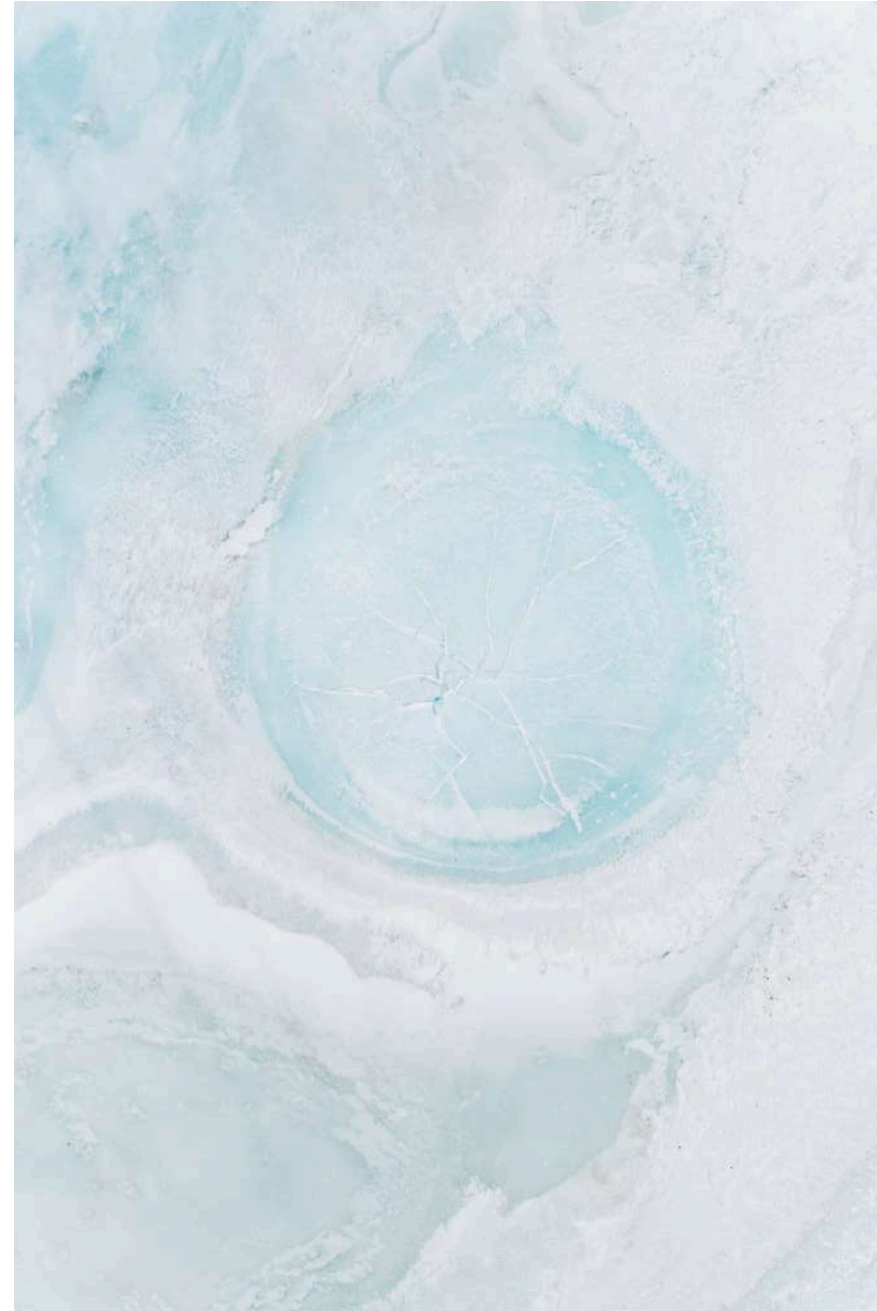

This Zone presents a serene haven for those seeking solace from the stresses of daily life. Built to harness the revitalizing properties of water, this Zone showcases an array of products that let you revel in the calming advantages of interior spaces whilst immersing yourself in the natural beauty of the outdoors. Whether you crave relief from the bustle of city life or yearn for a quiet place to gather your thoughts and relax, the Aqua Zone is the perfect destination.

MARBELLA





Marbella outdoor shower boasts clean lines and a minimalist design, making it a timeless and elegant addition to any outdoor space. It's perfect for use by the pool or in outdoor bathrooms.

Crafted by hand using natural Kanfanar stone or ceramics by Marazzi, Marbella shower serves as a symbolic tribute to nature. It seamlessly blends in with the landscape, becoming an integral part of it, and ages gracefully along with nature's transformative journey.

The porcelain slabs we utilize are sourced from Marazzi, an esteemed Italian manufacturer with whom we have forged a robust friendship and partnership. Marazzi's origins trace back to 1935 in Sassuolo, and it presently embodies the pinnacle of Italian style and manufacturing excellence in the realm of interior decoration and design.

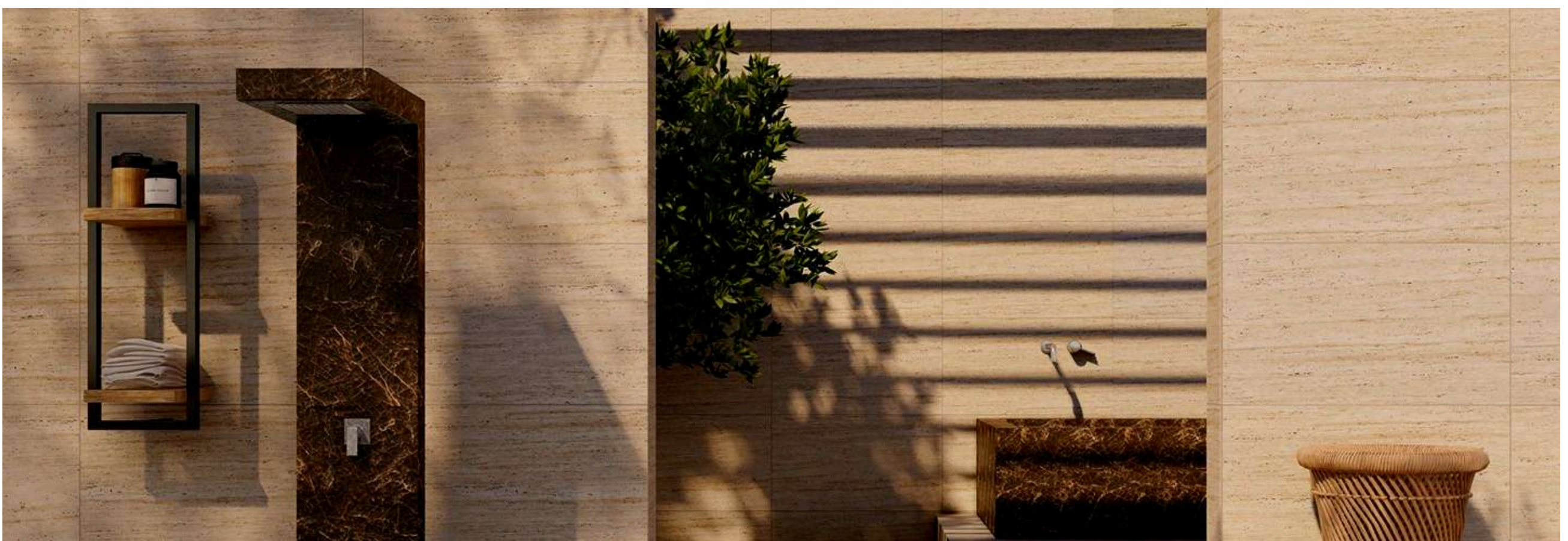

Product: Outdoor shower *Marbella*
Material: Marazzi - Saint Laurent
Code: MARMSL



LIMESTONE KANFANAR

absorption 0.68 %
compressive strength 186.00 MPA
flexural strength 9.6 MPa
abrasion resistance 14

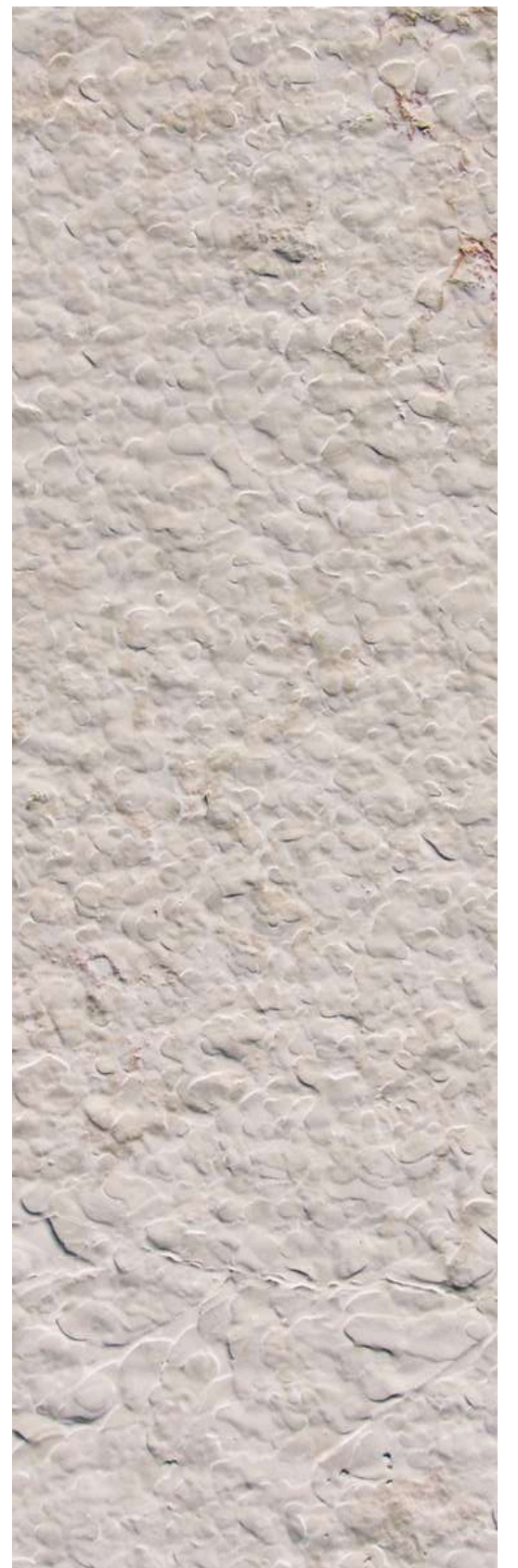

Polished / Bush hammered +brushed / Sandblasted+brushed / Rigato / Flamed+brushed

DECORS BY MARAZZI

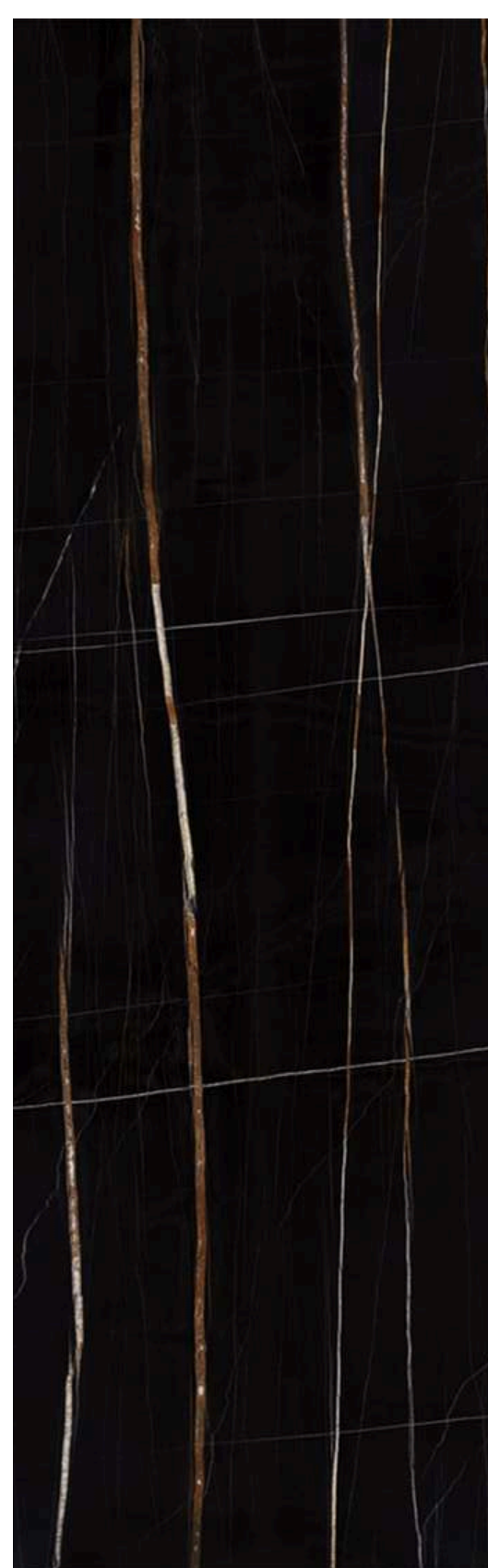

Sahara Noir / Statuario / Saint Laurent / Golden White / Grigio Carnico

DECORS BY MARAZZI

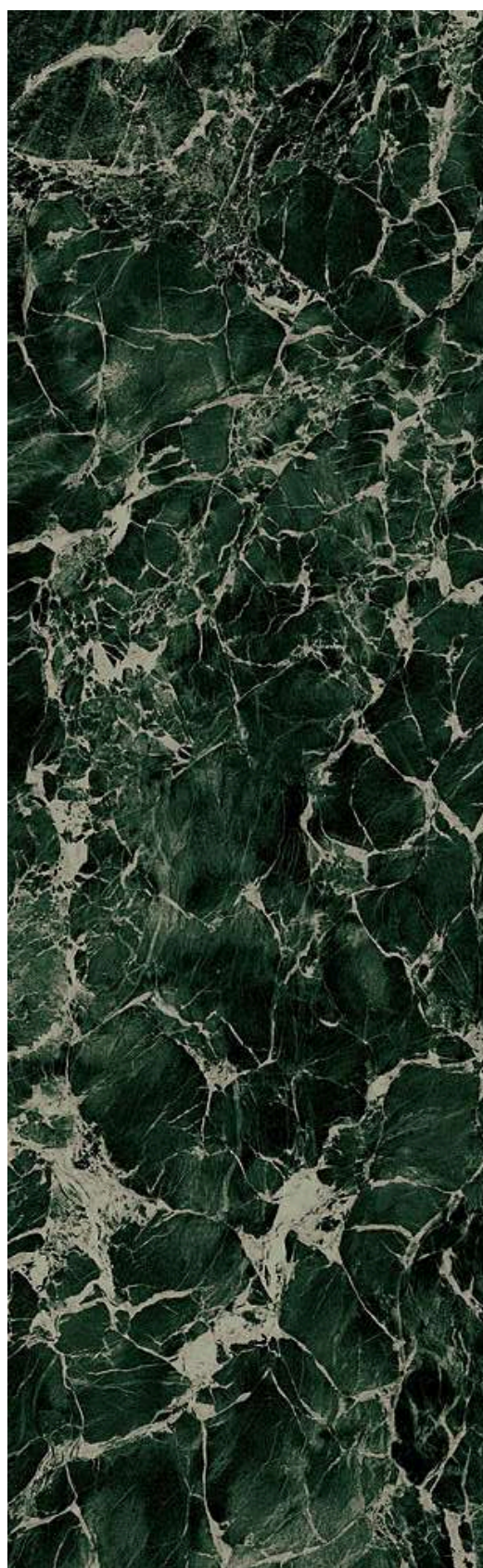

Corten / Rovere Francese / Verde Avere / Limestone Ivory / Sodalite Blu



PRODUCT DIMENSIONS

STONE

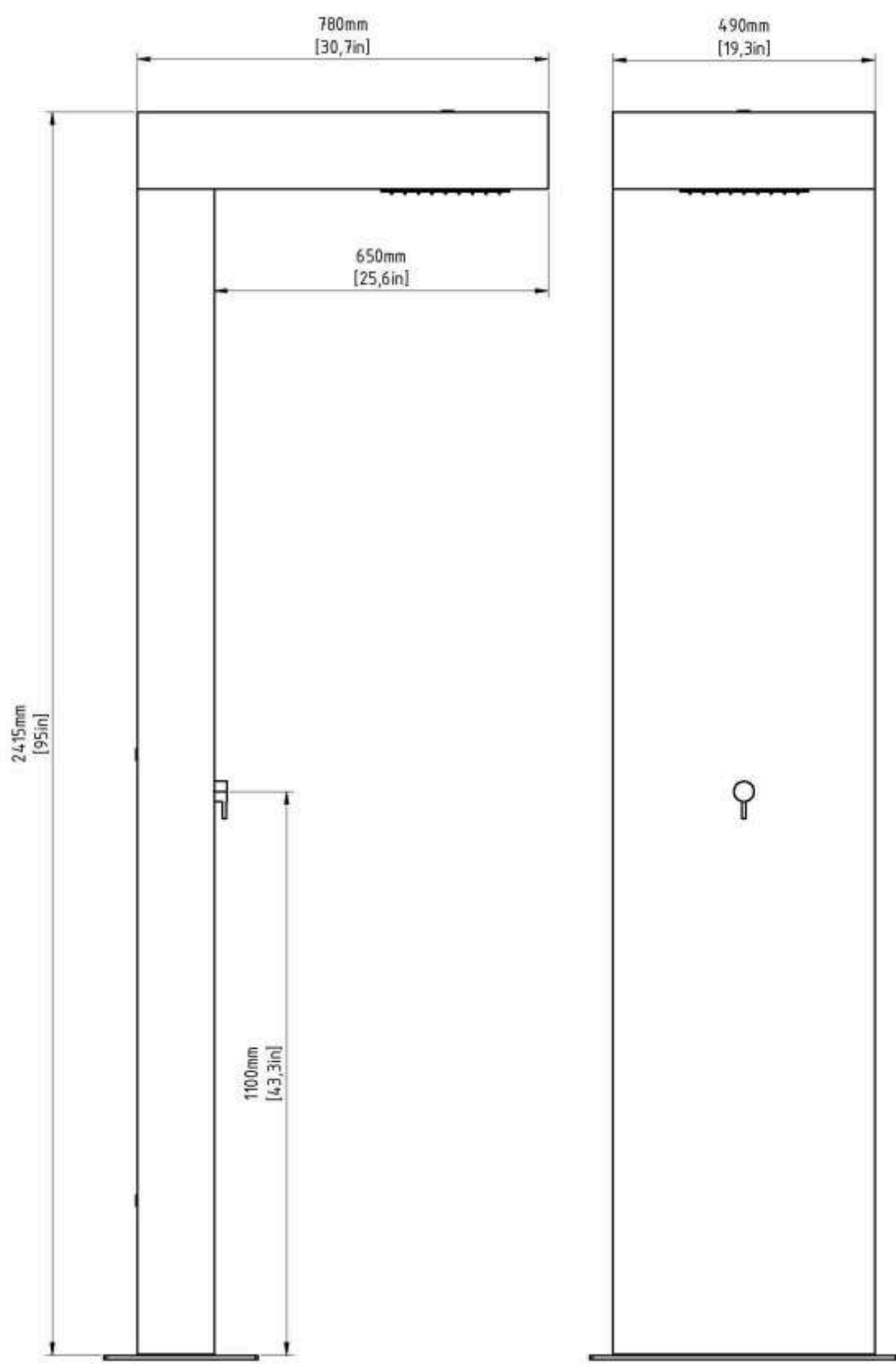

CERAMICS

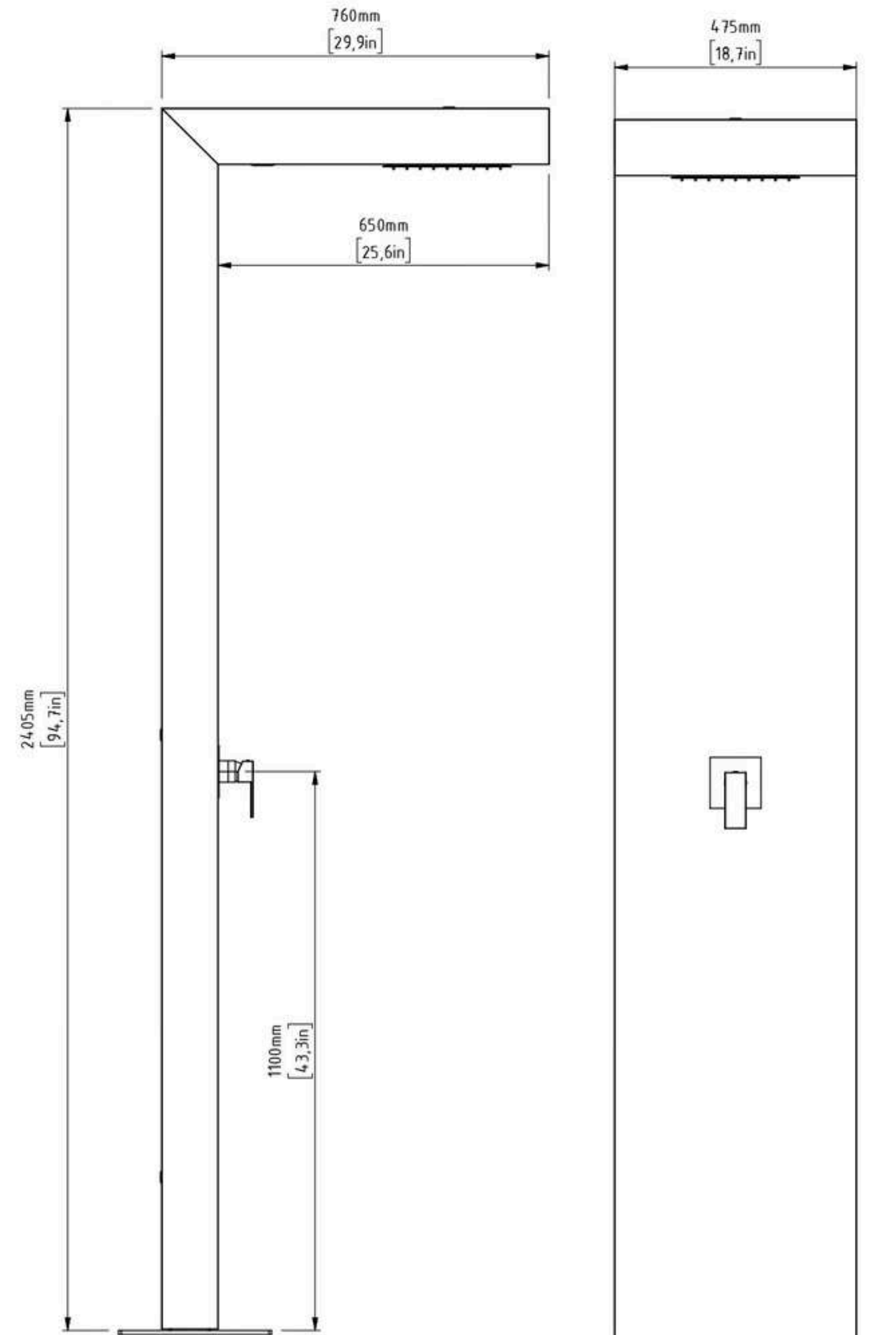

255kg / 562lbs









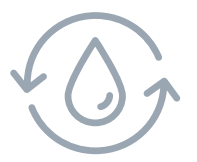

144 kg/318 lbs









Product: Coffee table *Ponte* / Outdoor shower *Marbella*
Material: Kanfanar - rigato
Code: CTPXLKR / MARKR

SHOWER SYSTEM STANDARD FEATURES



-  4 flexible stainless steel knitted hose 1/2"
-  2-way mixing mechanism with faucet and handle designed by Mariner Rubinetterie
-  Ecotech shower head by Mariner Rubinetterie which enables water savings of up to 50 %
-  The informed Nattura S shower catalyst with beneficial well-being effects
-  Protective shower cover
-  Protective base plate cover
-  Water flow 4-8 L / min

SHOWER SYSTEM ADDITIONAL FEATURES

-  Ambient LED lighting designed by Filix
-  Anti-frost heating cable
-  Logo engraving
-  Motion sensor
-  Additional shower handle
-  Hot water tank (*exclusively available in dark decors*)



Product: Custom made Outdoor shower *Marbella*
Material: Granite Assoluto Nero - brushed
Code: MARGANBLEL





Product: Outdoor shower *Marbella*
Material: Marazzi - Saint Laurent
Code: MARMSL





Product: Outdoor shower *Marbella*
Material: Kanfanar - sandblasted+brushed
Code: MARKSBLEL





Product: Custom made Outdoor shower *Marbella*

Material: Avorio - polished

Code: MARAPLE

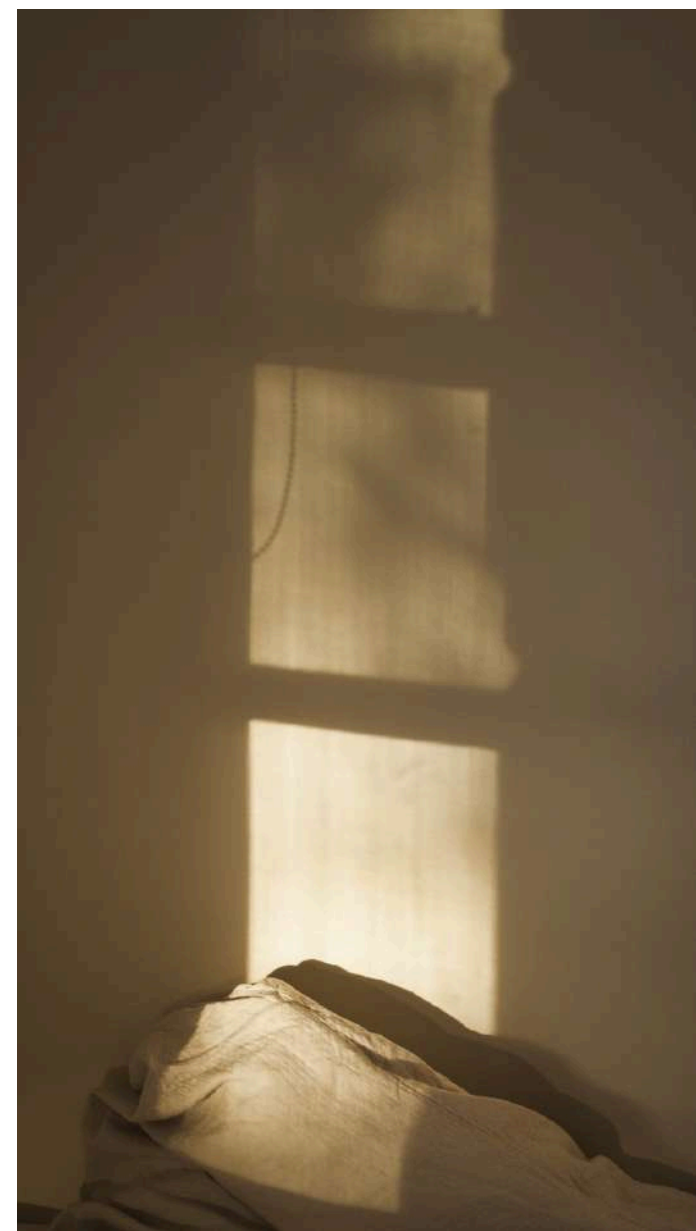





Product: Outdoor shower *Marbella*
Material: Kanfanar - bush hammered+brushed
Code: MARKBHB



Product: Outdoor shower *Marbella*
Material: Kanfanar - bush hammered+brushed
Code: MARKBHB

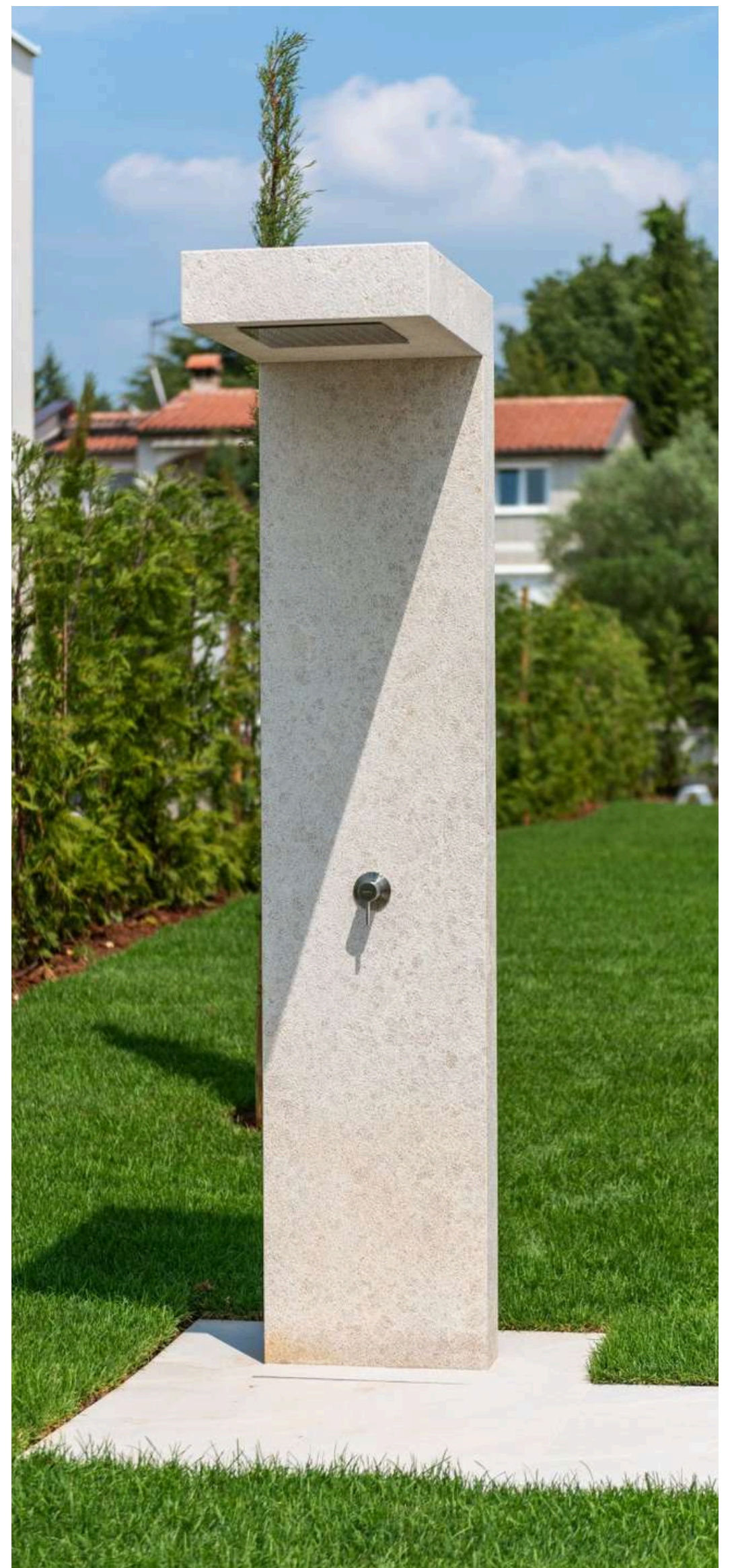



ODINO



Product: Outdoor shower *Odino*
Material: Marazzi Golden White
Code: ODMGW

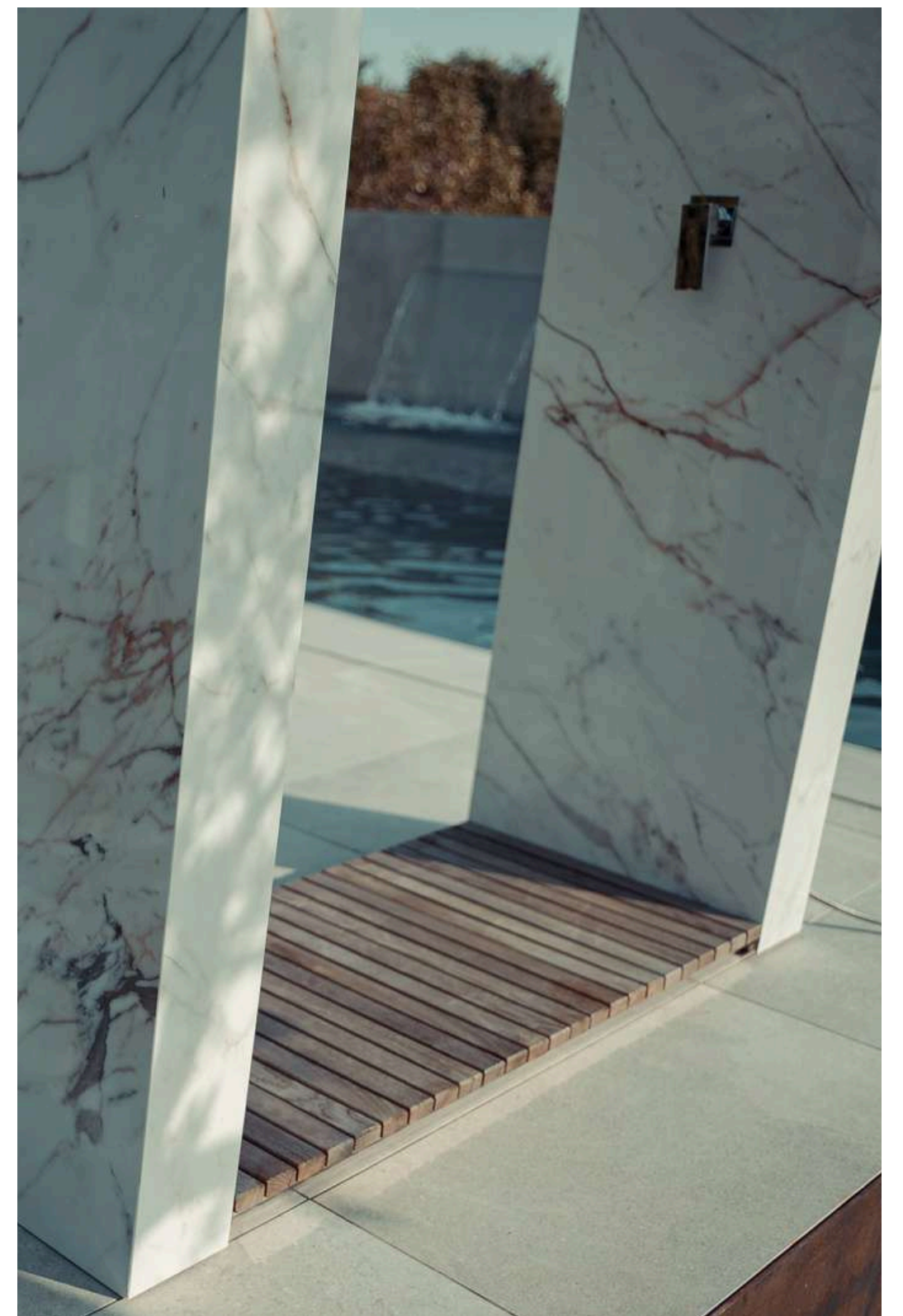

Product: Floor decking
Material: Thermal Ash
Code: FD







A true embodiment of elegance and contemporary design, Odino stands as the flagship of the esteemed KORTA collections. With its remarkable simplicity and clean lines, this outdoor shower exudes an air of timeless beauty that effortlessly captures attention. The Odino Outdoor Shower is a stunning amalgamation of monumentality and grace, resulting in a truly mesmerizing piece. Its sleek and streamlined structure commands a strong presence, while its refined aesthetic offers a touch of refinement to any outdoor space.

Beyond its striking appearance, Odino also boasts exceptional functionality. Designed to provide a revitalizing shower experience, it delivers a cascade of water with precision and grace. In addition to its functional excellence, Odino possesses an inherent photogenic quality. Every angle and detail has been meticulously crafted to ensure breathtaking visuals, making it a remarkable focal point for any outdoor setting. Capture the essence of contemporary style and create picture-perfect moments with Odino's captivating allure.

LIMESTONE KANFANAR

absorption 0.68 %
compressive strength 186.00 MPA
flexural strength 9.6 MPa
abrasion resistance 14

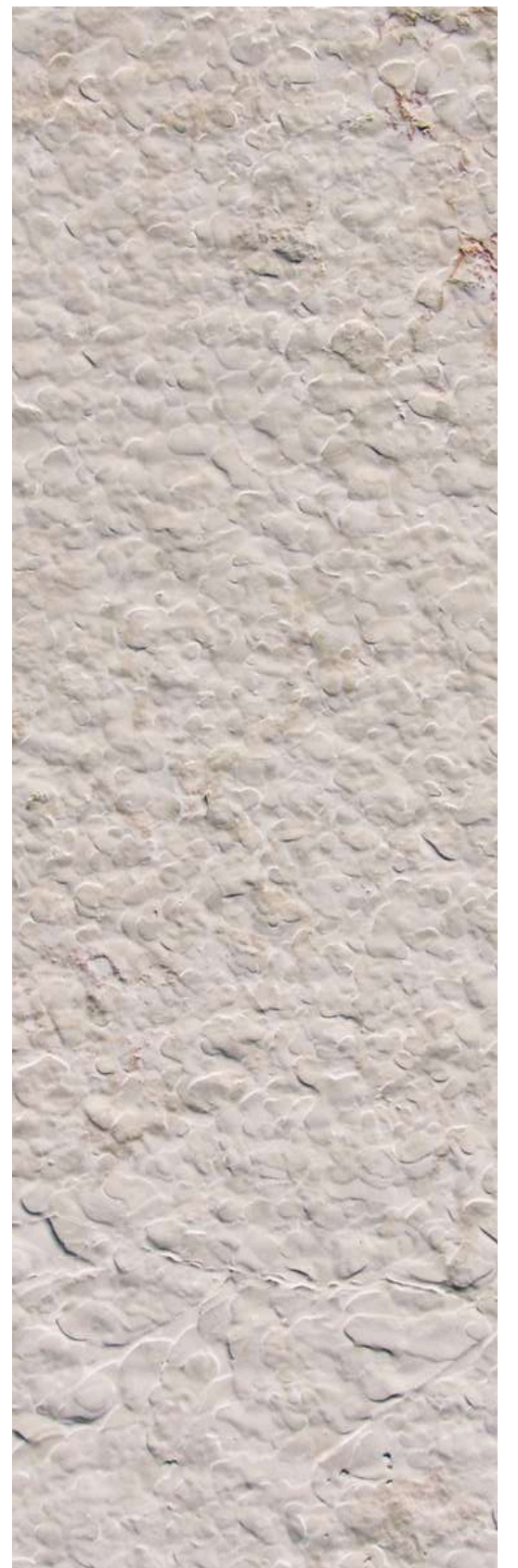

Polished / Bush hammered +brushed / Sandblasted+brushed / Rigato / Flamed+brushed

DECORS BY MARAZZI

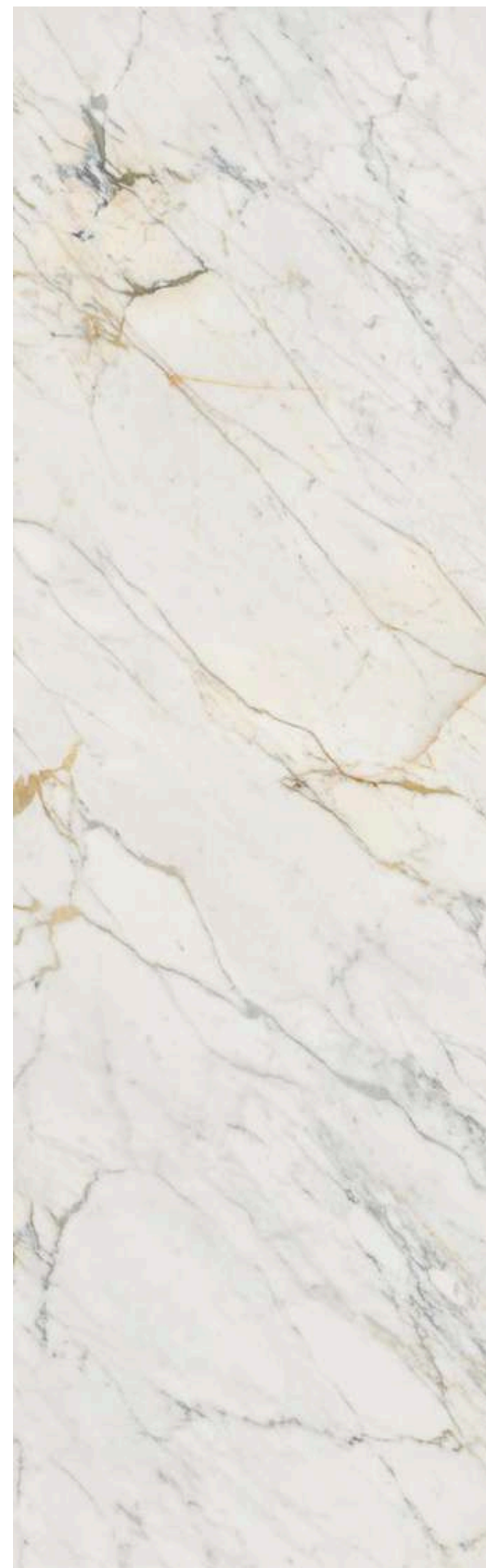
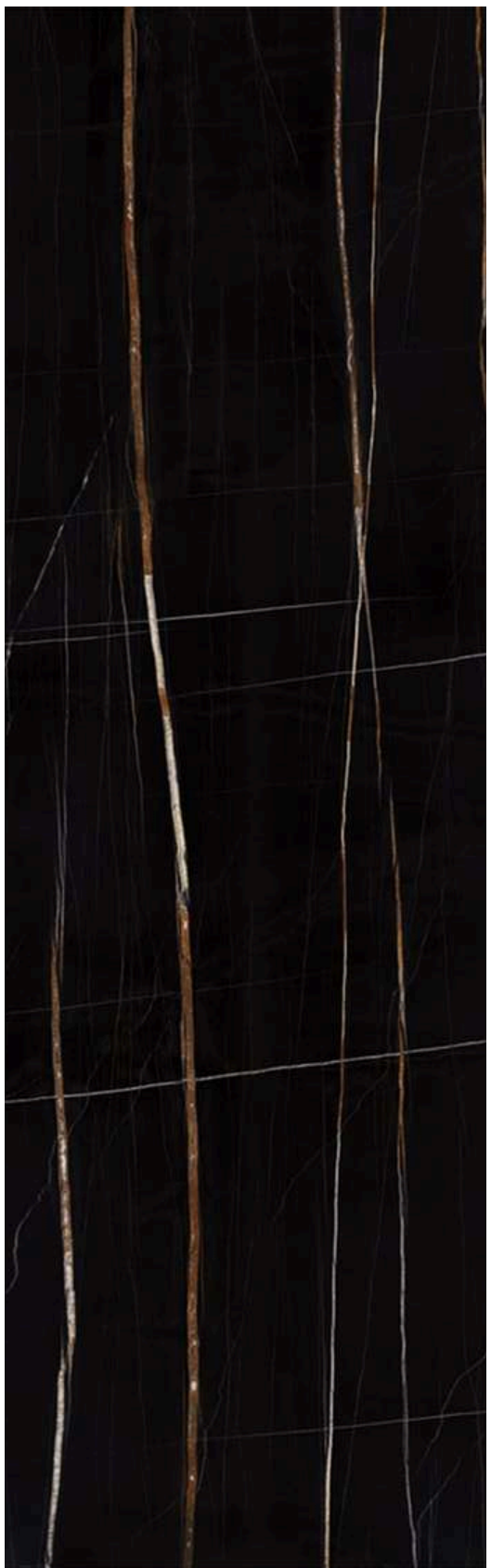

Sahara Noir / Statuario / Saint Laurent / Golden White / Grigio Carnico

DECORS BY MARAZZI

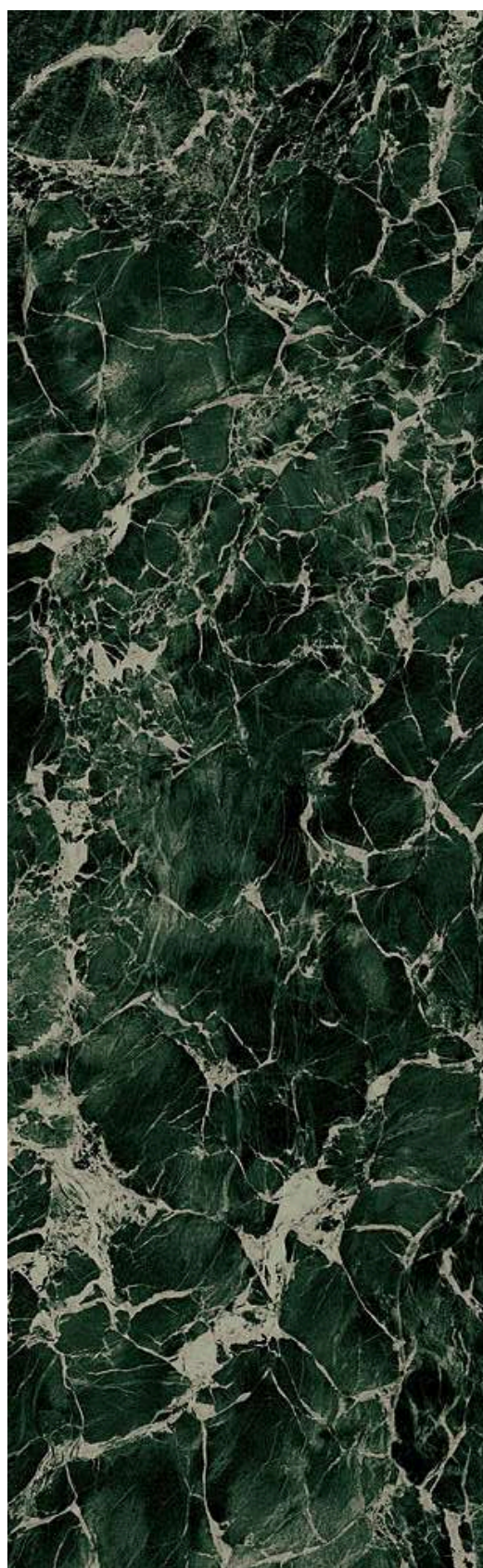

Corten / Rovere Francese / Verde Aver / Limestone Ivory / Sodalite Blu

PRODUCT DIMENSIONS

STONE

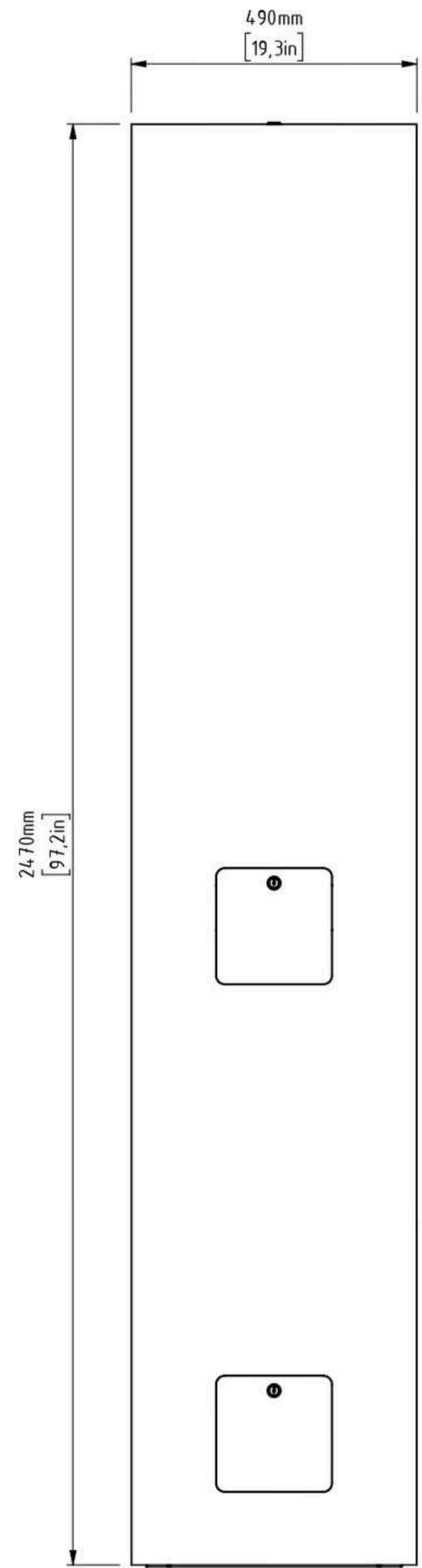
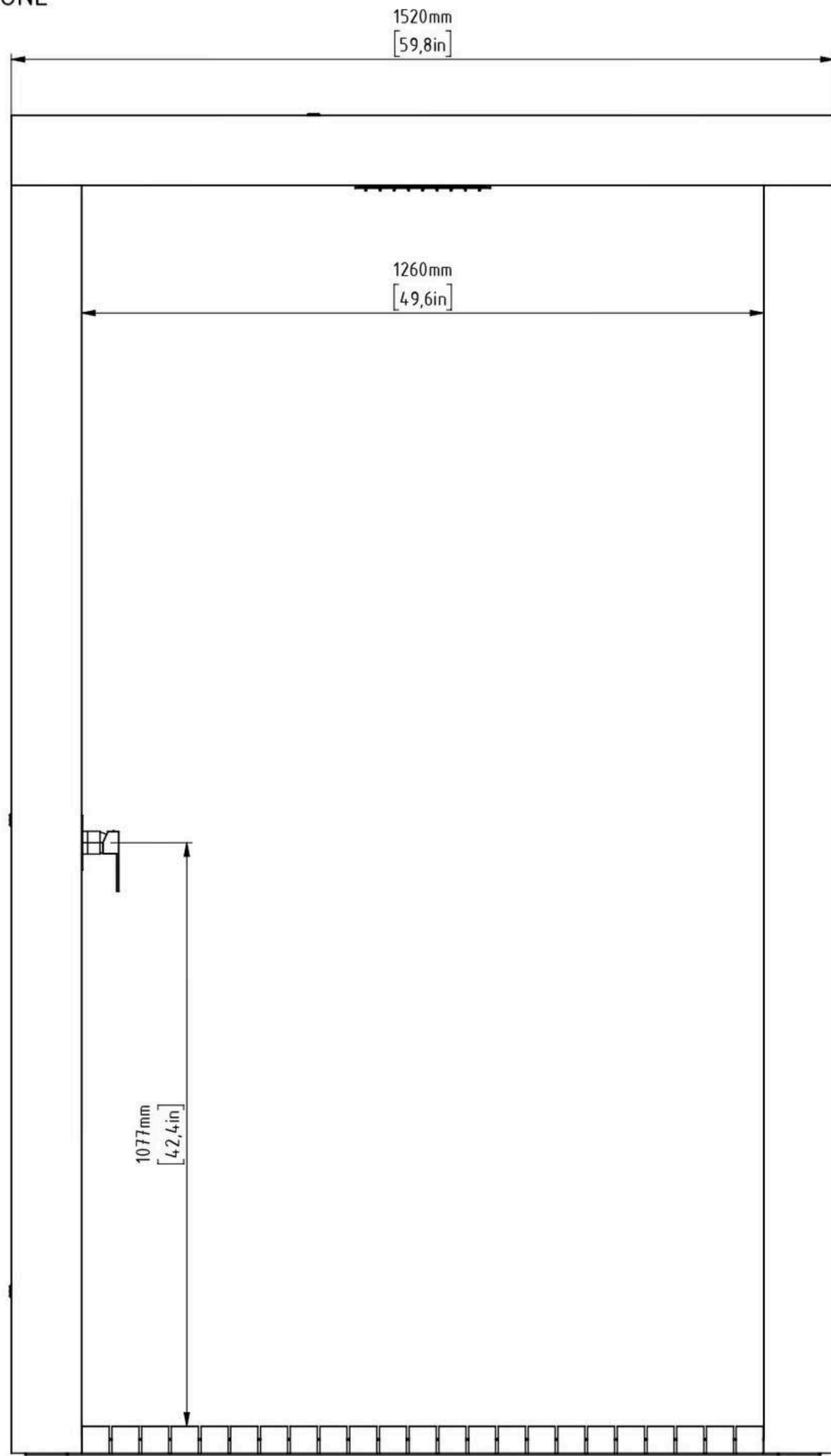





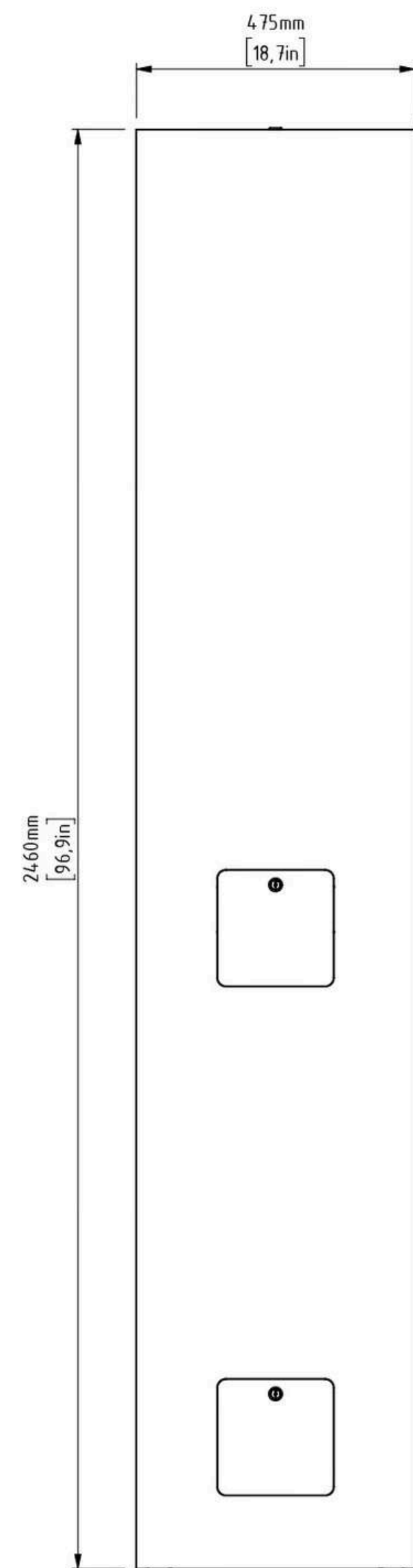
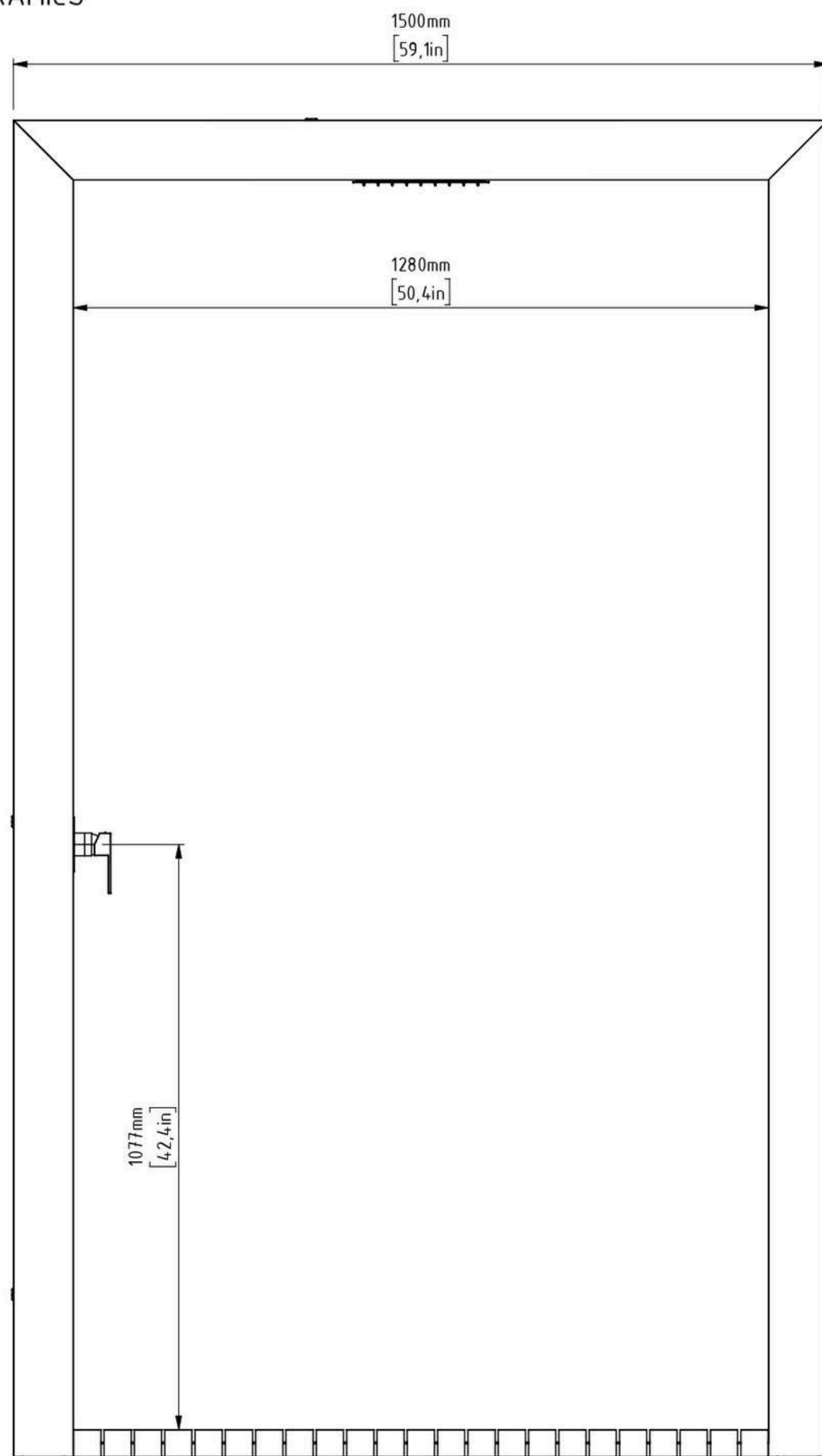

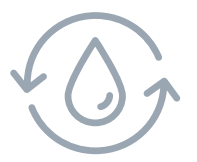

PRODUCT DIMENSIONS

CERAMICS









SHOWER SYSTEM STANDARD FEATURES



-  4 flexible stainless steel knitted hose 1/2"
-  2-way mixing mechanism with faucet and handle designed by Mariner Rubinetterie
-  Ecotech shower head by Mariner Rubinetterie which enables water savings of up to 50 %
-  The informed Nattura S shower catalyst with beneficial well-being effects
-  Protective shower cover
-  Protective base plate cover
-  Water flow 4-8 L / min

SHOWER SYSTEM ADDITIONAL FEATURES

-  Ambient LED lighting designed by Filix
-  Anti-frost heating cable
-  Logo engraving
-  Motion sensor
-  Additional shower handle
-  Hot water tank (*exclusively available in dark decors*)





Product: Outdoor shower *Odino*
Material: Kanfanar - polished
Code: ODKP

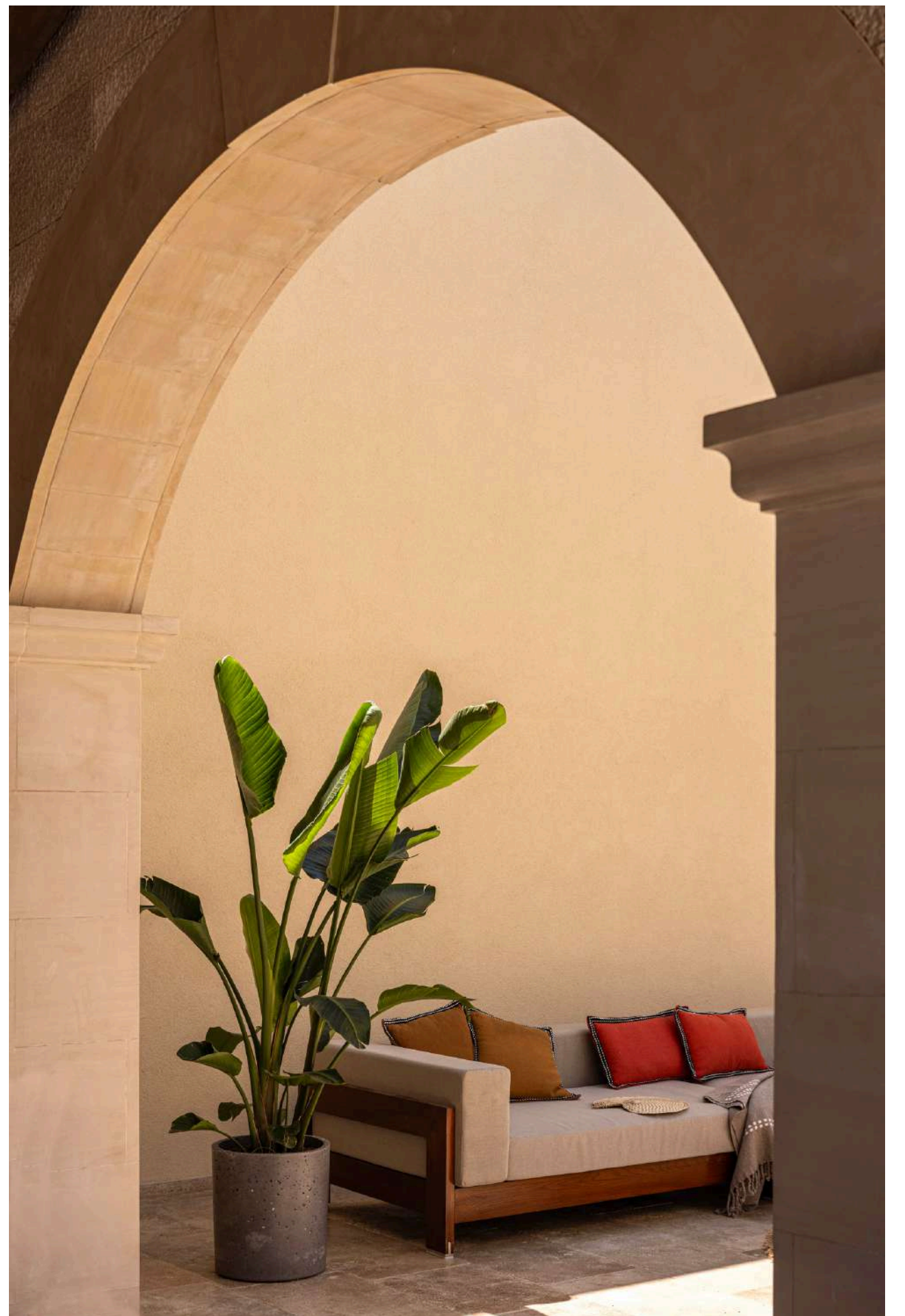

MINIMO



Our idea was to create something more than an outdoor shower - a sculpture with a feature of an outdoor shower. The uniqueness behind MINIMO is the passion for natural stone and hand-crafting. We can proudly say that we are the first company in history to produce outdoor showers from natural stone, completely assembled in the factory as serial production units, and delivered to customers in one piece.

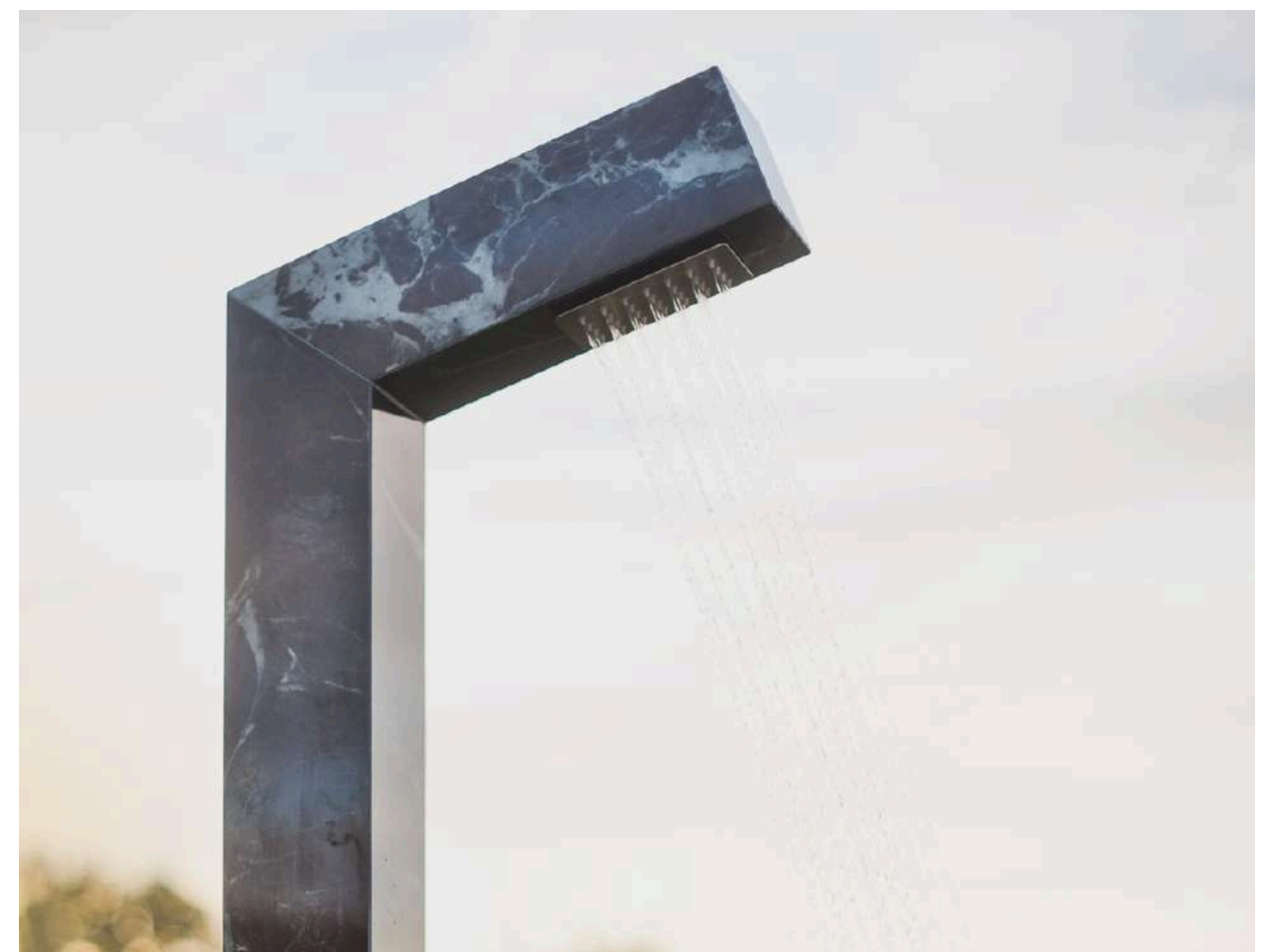

Product: Outdoor shower *Minimo*
Material: Marazzi Verde Aver
Code: MINMAV

MINIMO outdoor shower is made to stand out, elevate any exterior area, and give that wow effect to a backyard once it's complete. MINIMO, together with nature's aromatherapy such as plants, trees, and water, makes a blend that creates the perfect relaxing outdoor area.

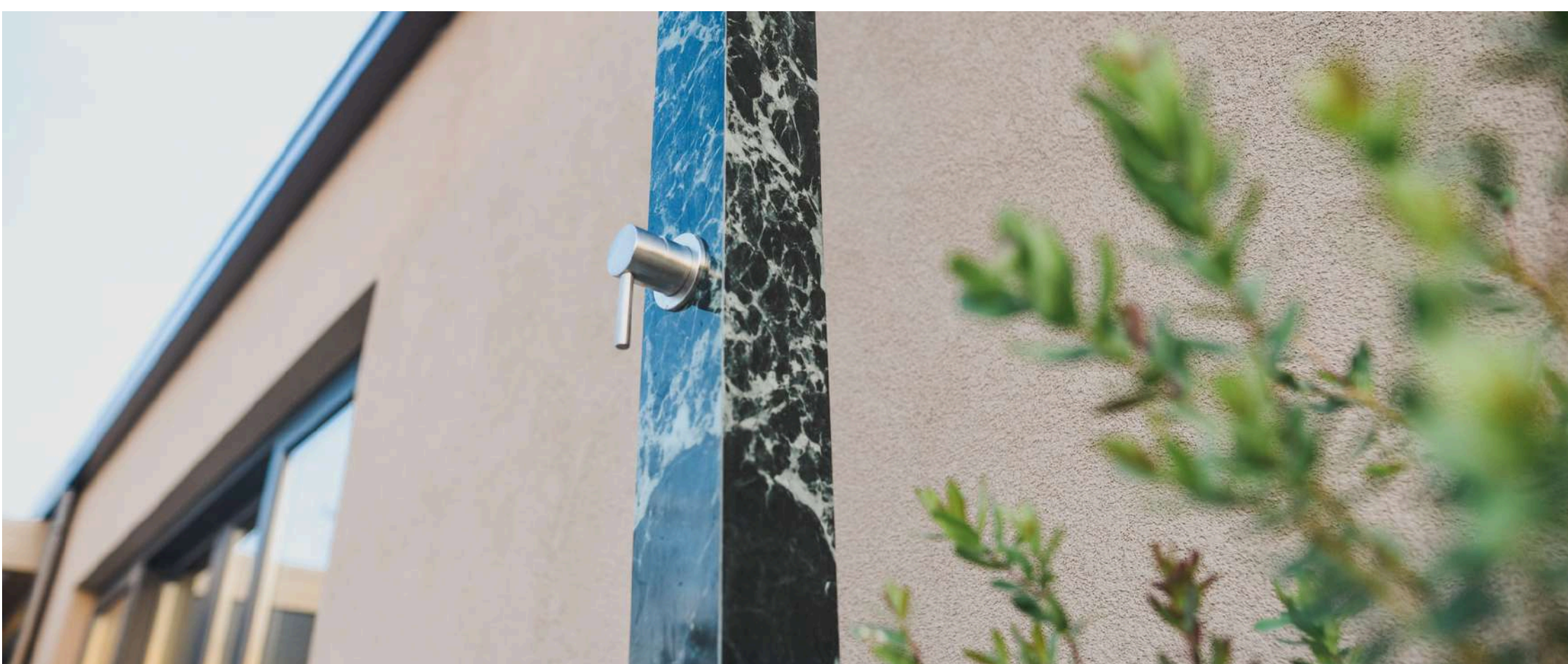

LIMESTONE KANFANAR

absorption 0.68 %
compressive strength 186.00 MPA
flexural strength 9.6 MPa
abrasion resistance 14

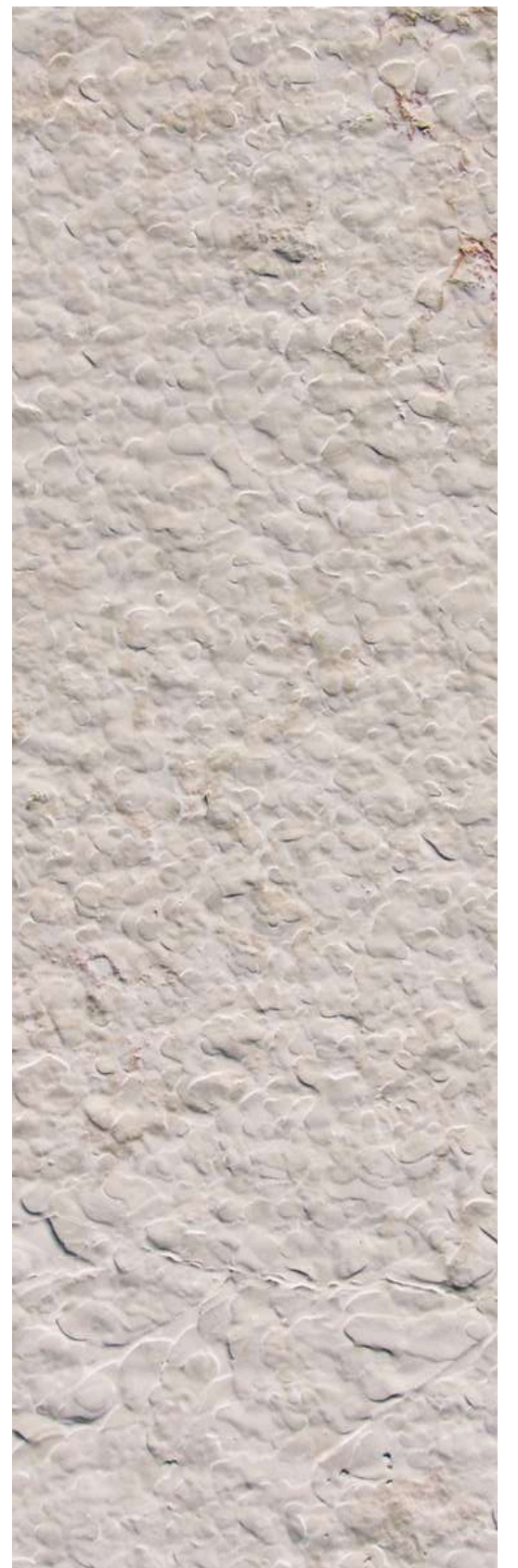

Polished / Bush hammered+brushed / Sandblasted+brushed / Rigato / Flamed+brushed

DECORS BY MARAZZI

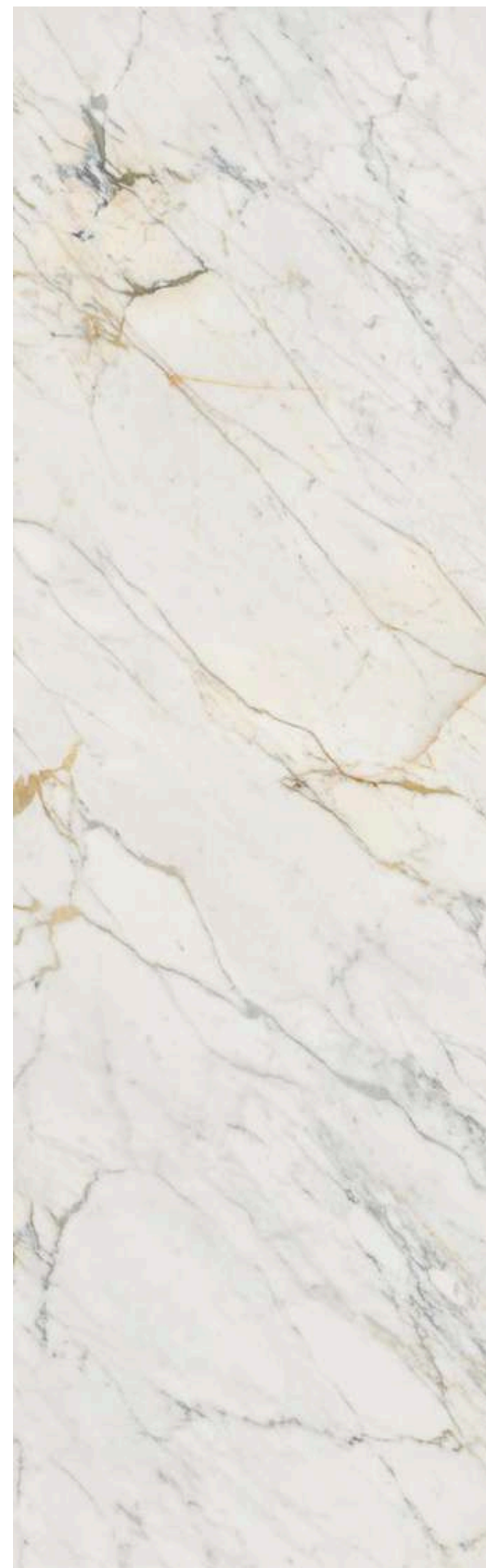
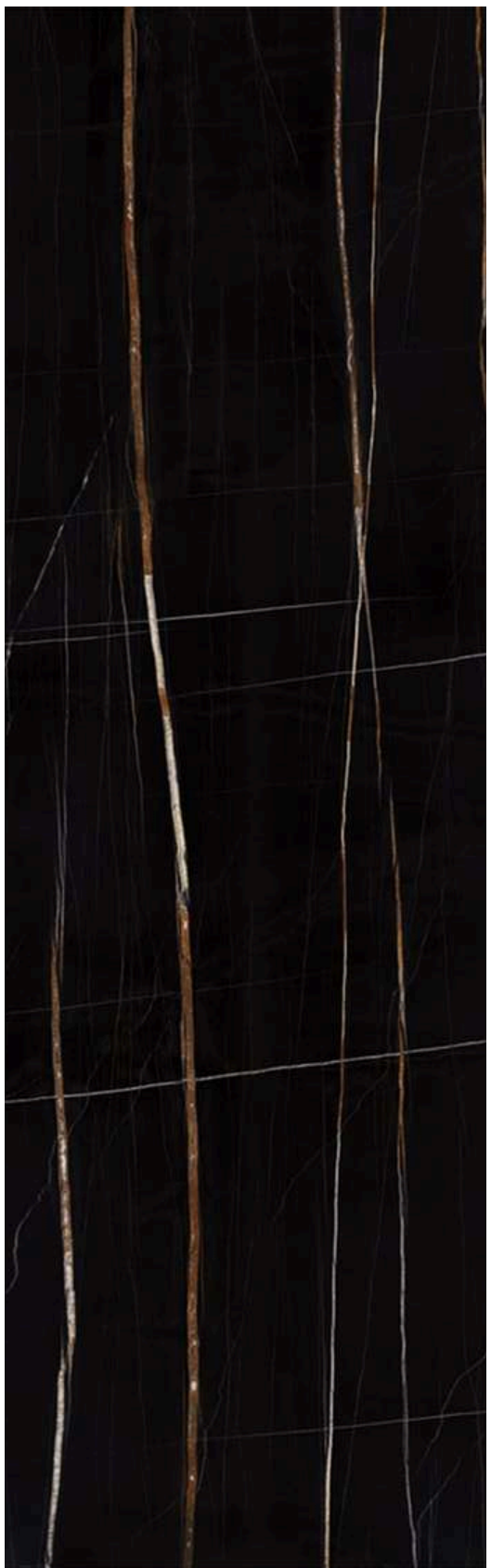

Sahara Noir / Statuario / Saint Laurent / Golden White / Grigio Carnico

DECORS BY MARAZZI



Corten / Rovere Francese / Verde Aver / Limestone Ivory / Sodalite Blu



Product: Custom made Outdoor shower *Minimo*
Material: Granit Assoluto Nero Honed
Code: MINGANHWT

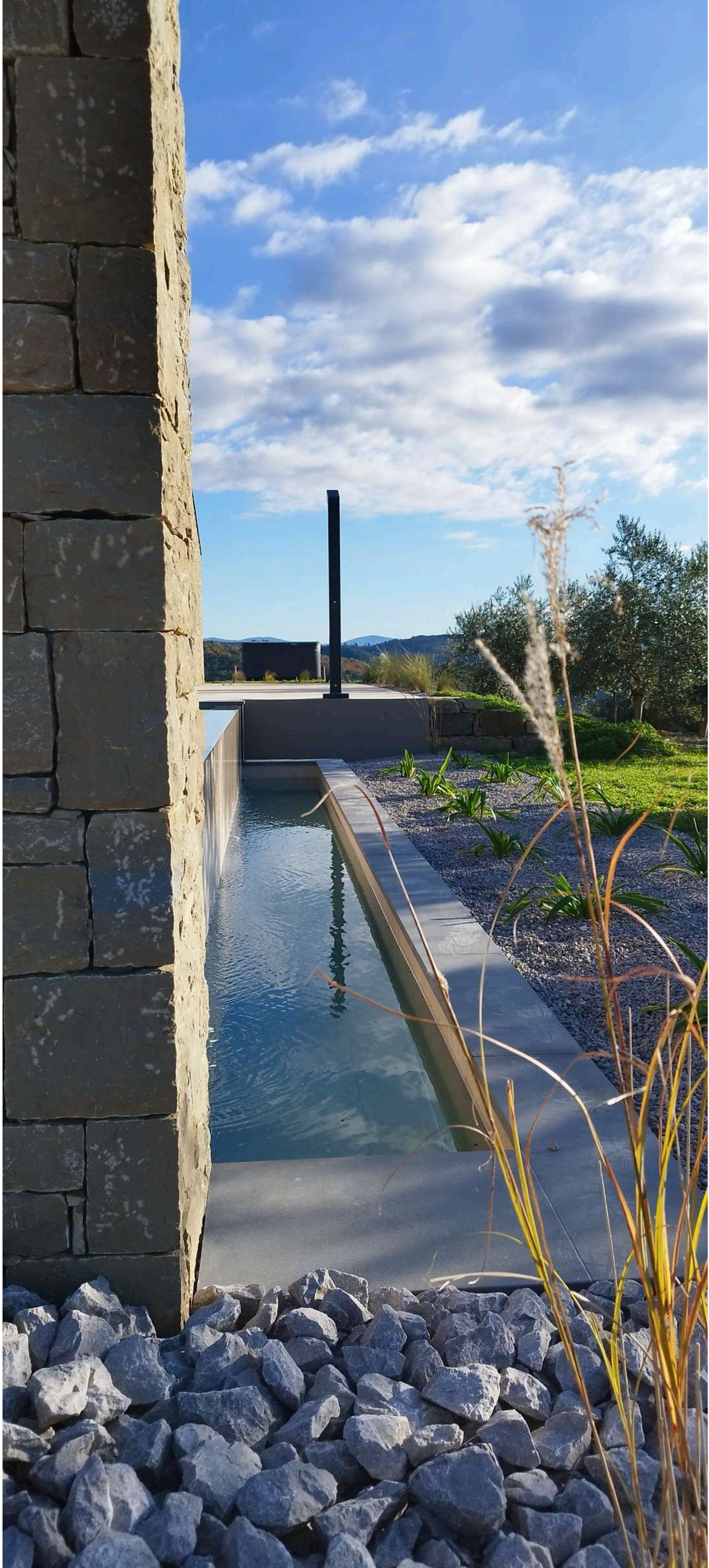

PRODUCT DIMENSIONS

STONE

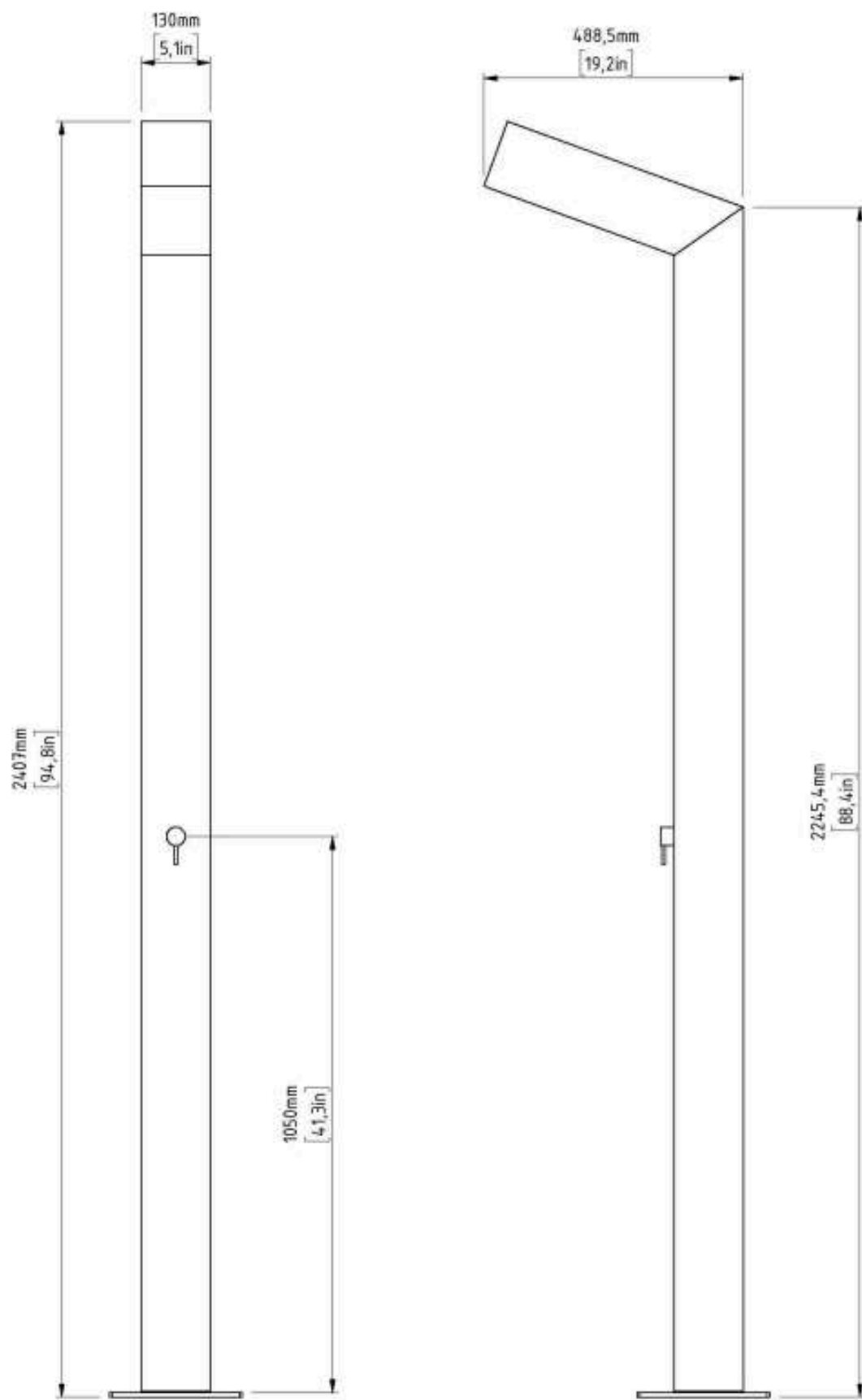

78kg / 172lbs



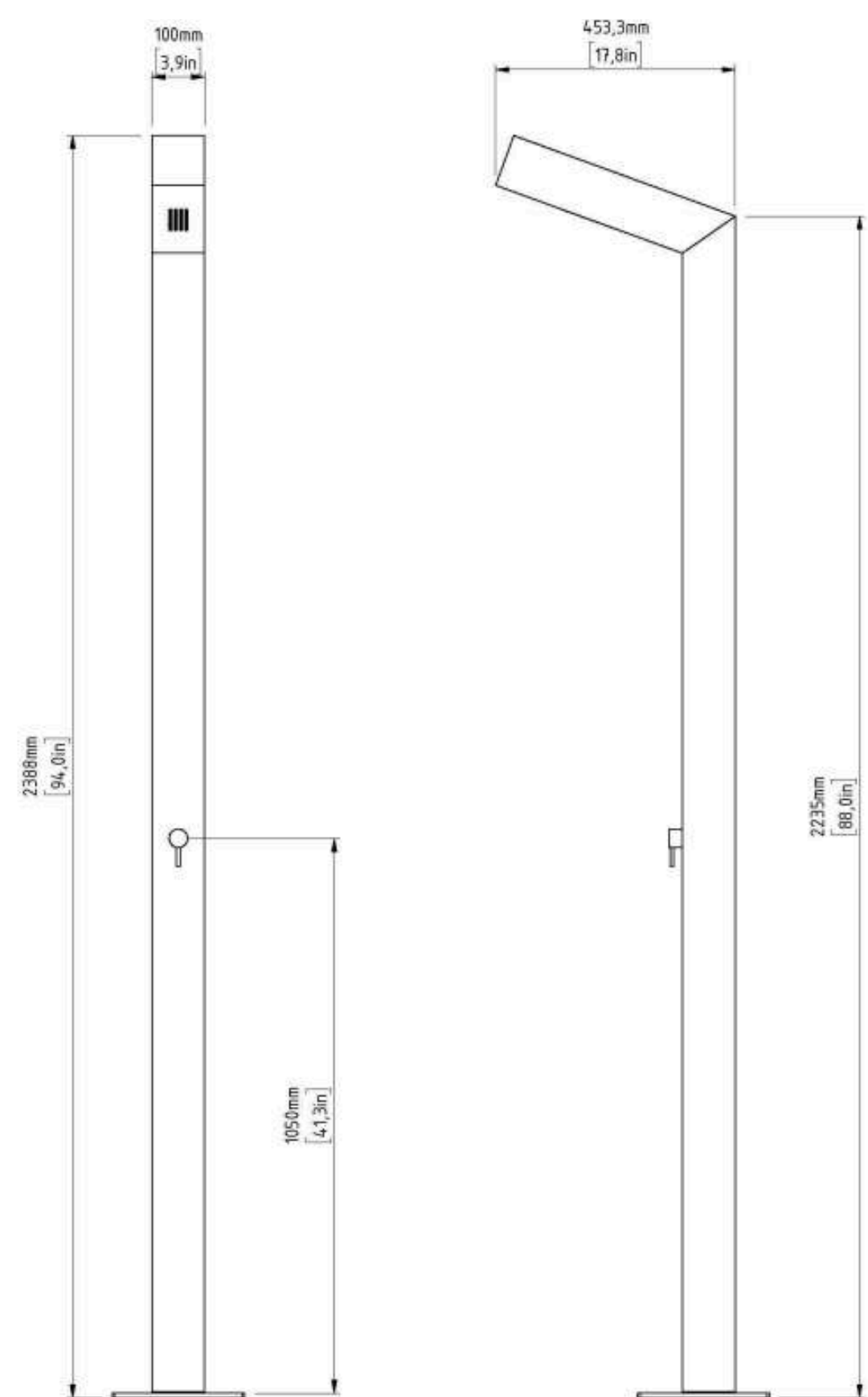



CERAMICS

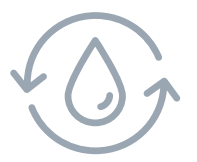







30kg / 66lbs

SHOWER SYSTEM STANDARD FEATURES



-  4 flexible stainless steel knitted hose 1/2"
-  2-way mixing mechanism with faucet and handle designed by Mariner Rubinetterie
-  Ecotech shower head by Mariner Rubinetterie which enables water savings of up to 50 %
-  The informed Nattura S shower catalyst with beneficial well-being effects
-  Protective shower cover
-  Protective base plate cover
-  Water flow 4-8 L / min

SHOWER SYSTEM ADDITIONAL FEATURES

-  Ambient LED lighting designed by Filix
-  Anti-frost heating cable
-  Logo engraving
-  Motion sensor
-  Additional shower handle
-  Hot water tank (*exclusively available in dark decors*)



Product: Outdoor shower *Minimo*
Material: Kanfanar - polished
Code: MINKP





MINNO



MINNO is our latest shower design, inspired by the Odino shower from our collection. Minno is primarily a design element that will enhance and add additional value to the exterior. With its remarkable, minimalistic frame shape, it can be a superb backdrop, especially when placed in front of a beautiful landscape



Product: Outdoor shower Minno
Material: Marazzi Verde Aver
Code: MINNMVAFD

Sleek lines and timeless aesthetics that complement any outdoor setting. Built from high-quality marble and porcelain for durability and style. Ideal for gardens, poolside areas, and luxurious outdoor retreats. Designed for seamless integration into your existing outdoor setup



LIMESTONE KANFANAR

absorption 0.68 %
compressive strength 186.00 MPA
flexural strength 9.6 MPa
abrasion resistance 14

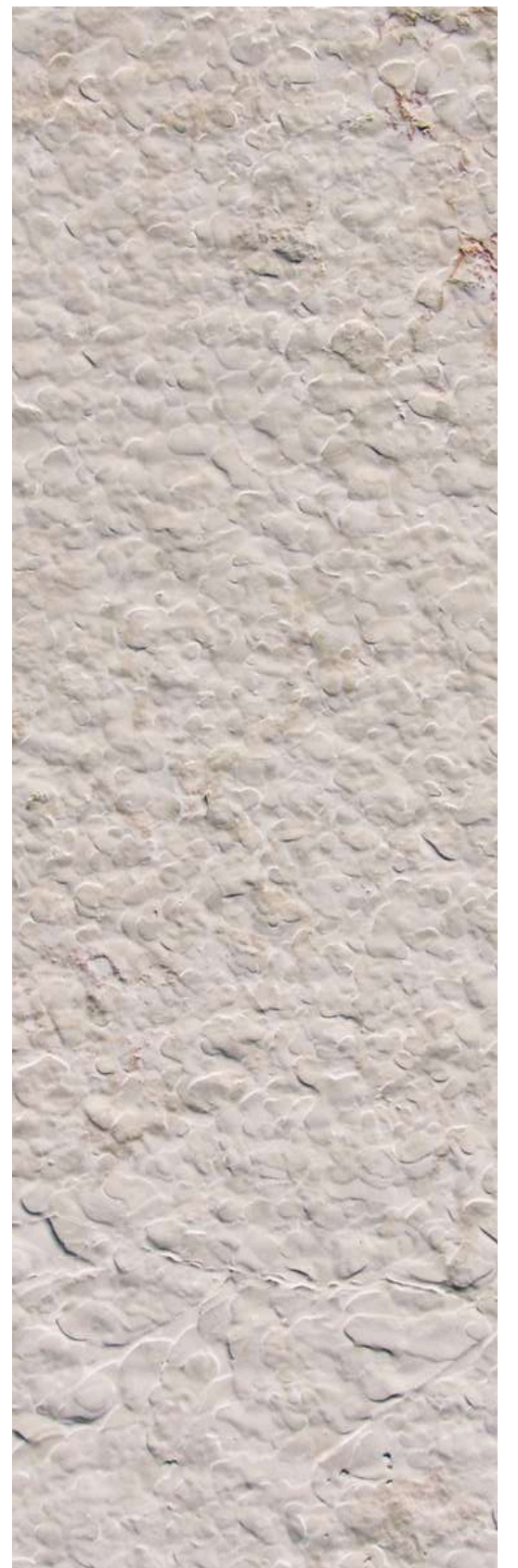

Polished / Bush hammered +brushed / Sandblasted+brushed / Rigato / Flamed+brushed

DECORS BY MARAZZI

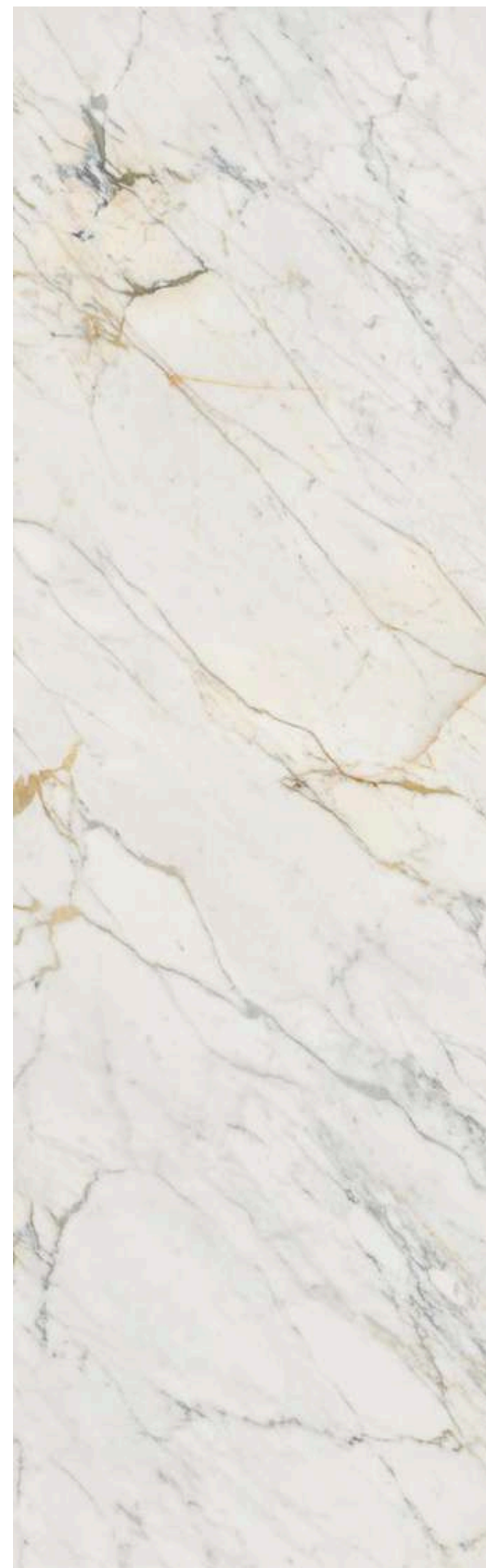
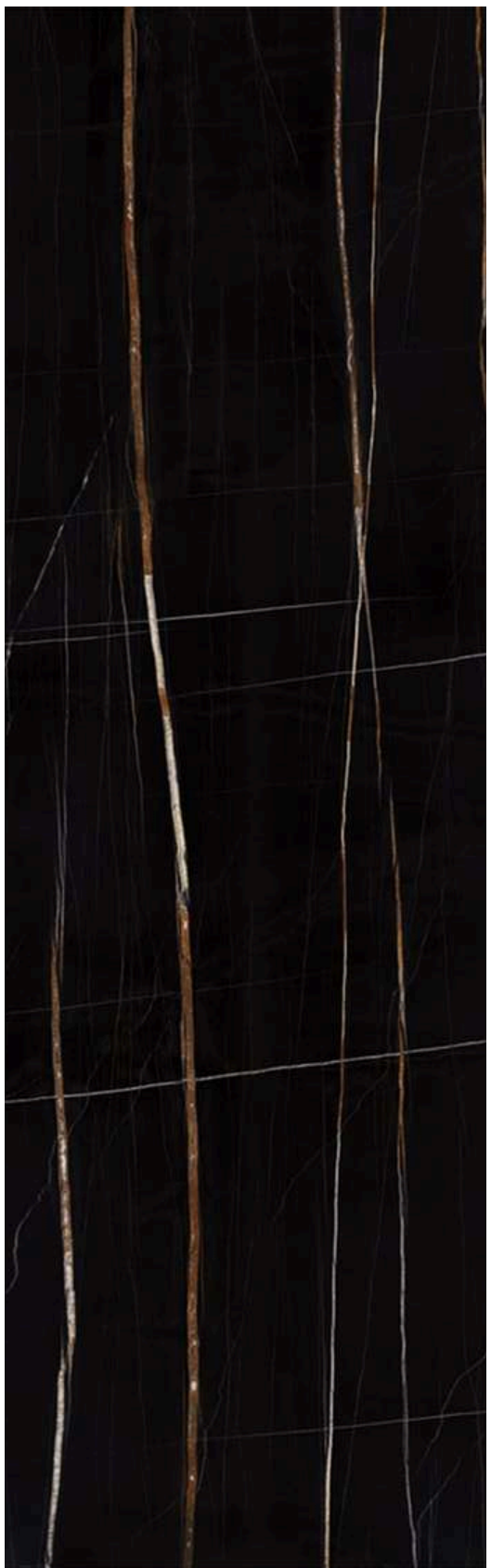

Sahara Noir / Statuario / Saint Laurent / Golden White / Grigio Carnico

DECORS BY MARAZZI



Corten / Rovere Francese / Verde Aver / Limestone Ivory / Sodalite Blu

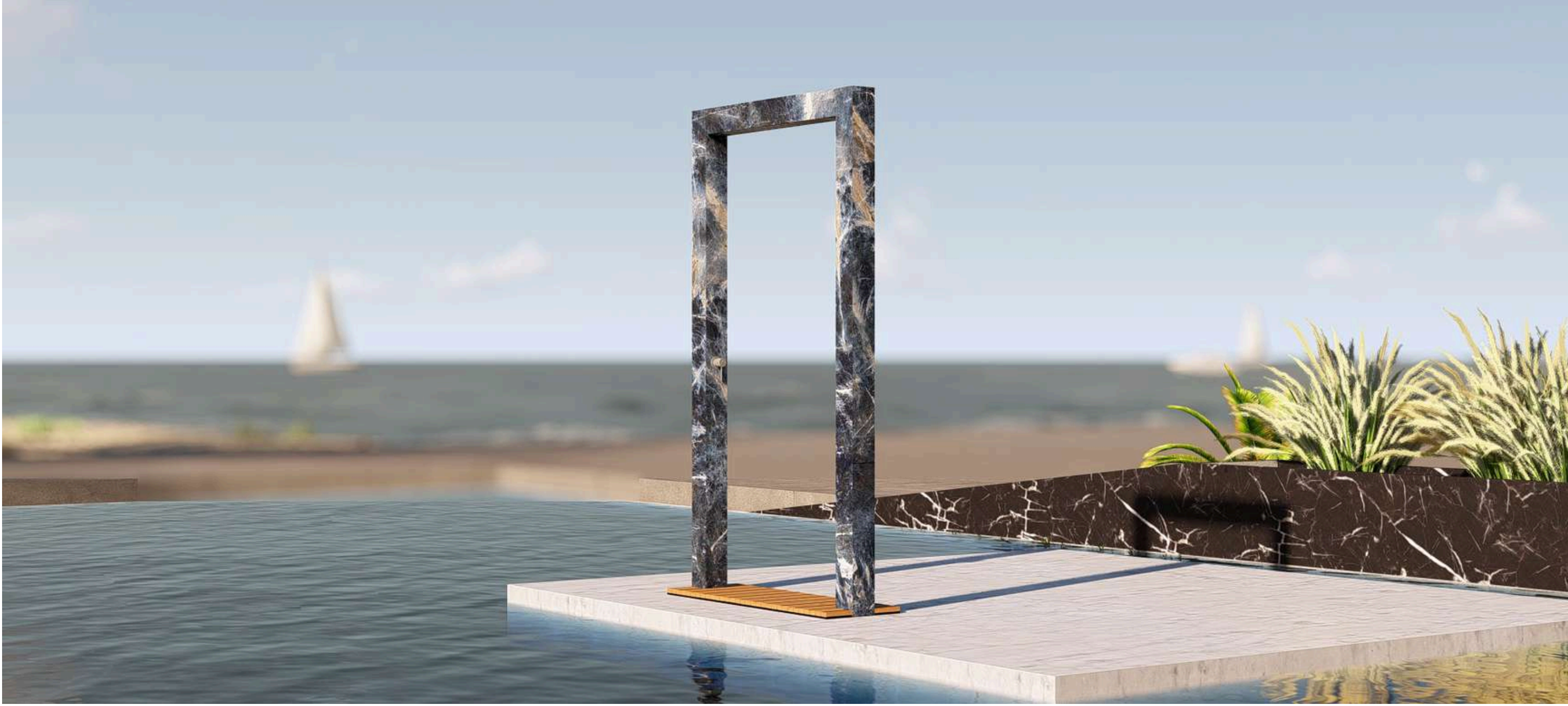

Product: Outdoor shower Minno
Material: Marazzi Sodalite Blu
Code: MINNMSBFD





PRODUCT DIMENSIONS

STONE

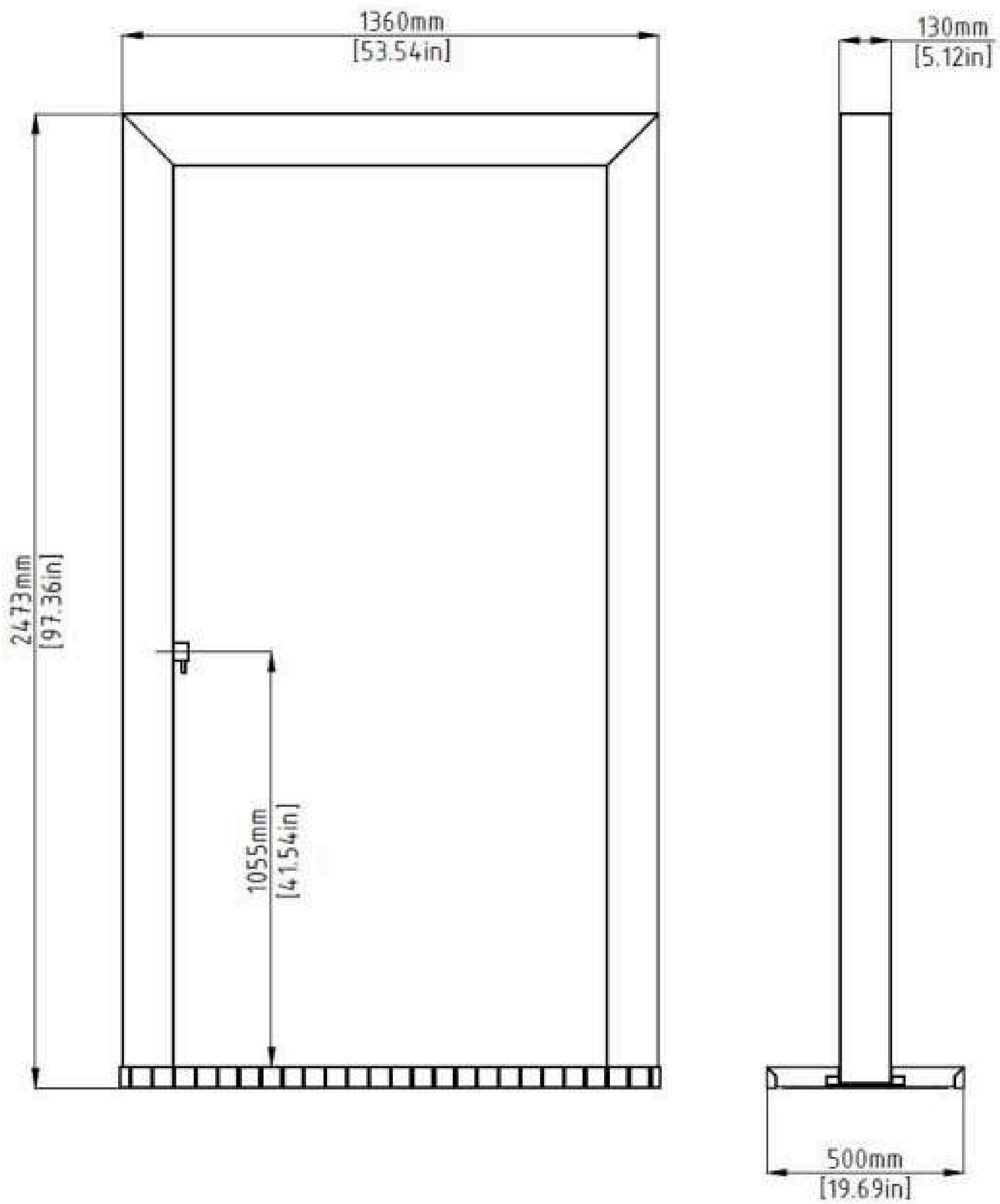

205kg / 452lbs

PRODUCT DIMENSIONS



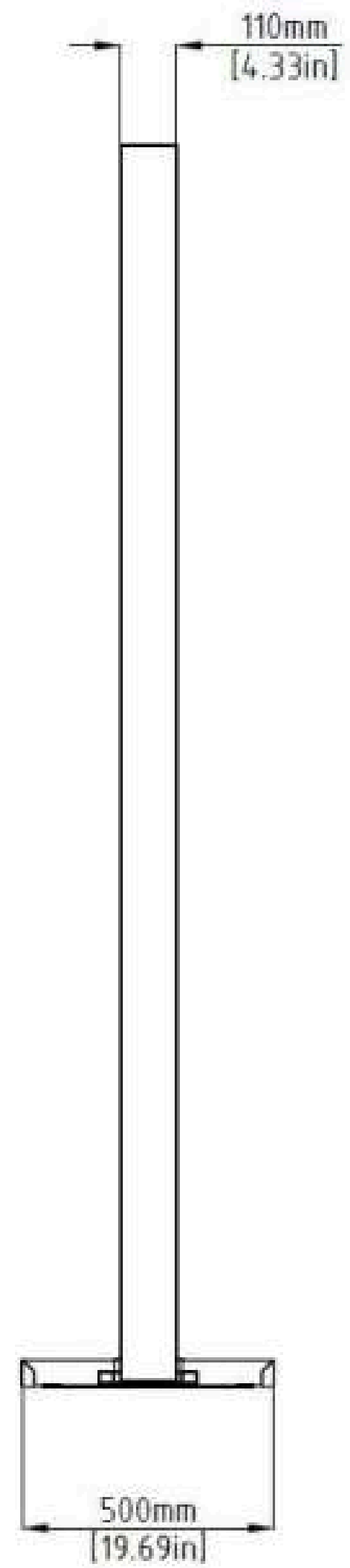
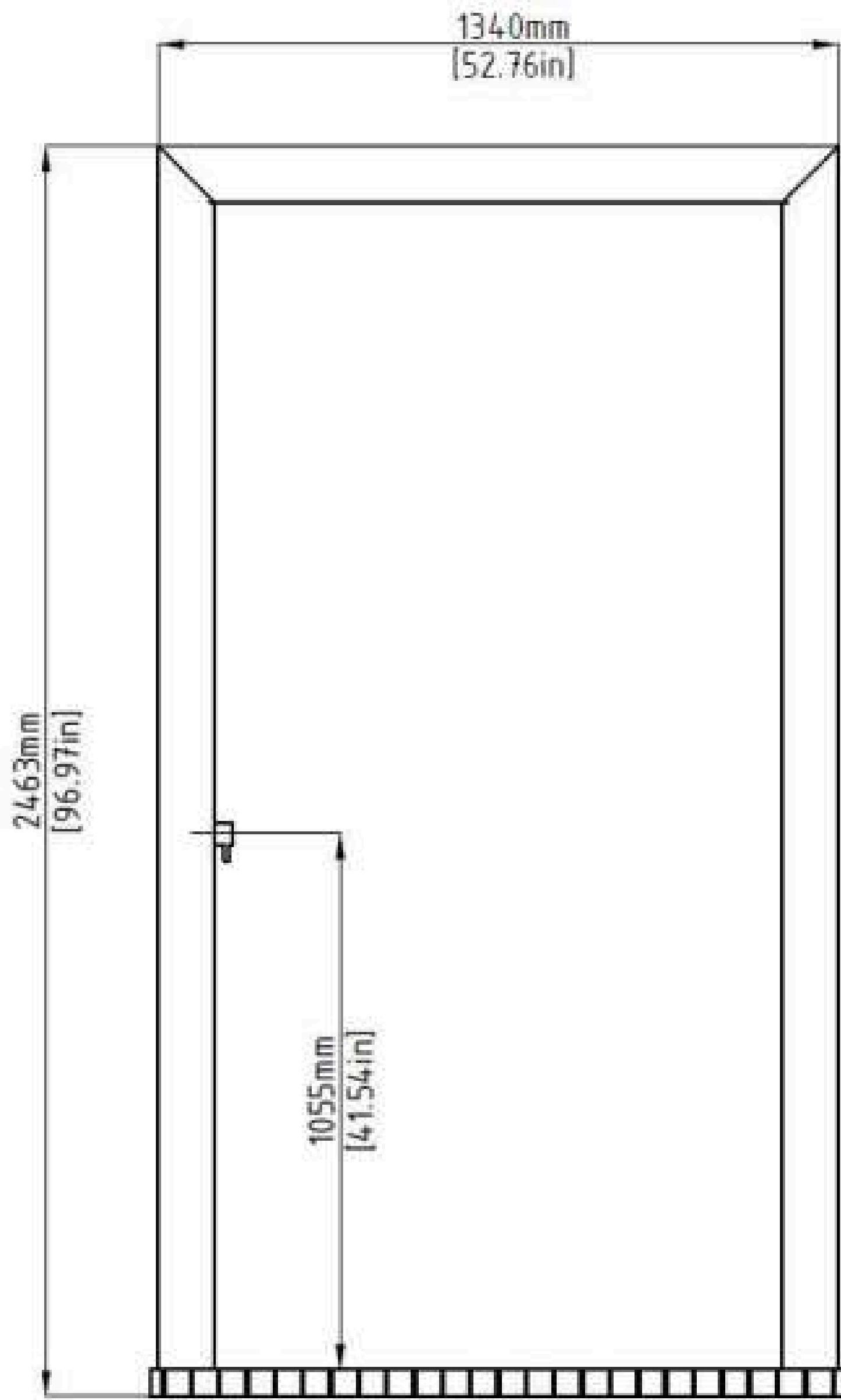



CERAMICS

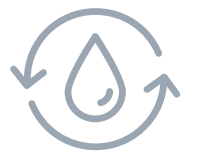







136kg/ 300lbs

SHOWER SYSTEM STANDARD FEATURES



-  4 flexible stainless steel knitted hose 1/2"
-  2-way mixing mechanism with faucet and handle designed by Mariner Rubinetterie
-  Ecotech shower head by Mariner Rubinetterie which enables water savings of up to 50 %
-  The informed Nattura S shower catalyst with beneficial well-being effects
-  Protective shower cover
-  Protective base plate cover
-  Water flow 4-8 L / min

SHOWER SYSTEM ADDITIONAL FEATURES

-  Ambient LED lighting designed by Filix
-  Anti-frost heating cable
-  Logo engraving
-  Motion sensor
-  Additional shower handle
-  Hot water tank (*exclusively available in dark decors*)



KADA



STONE FINISHES



Brushed/Honed

Bringing the outdoors indoors, and infusing our living spaces with plants and natural elements, undeniably uplifts our spirits. Yet, a similarly revitalizing effect can be achieved by taking the indoors outdoors. The trend of outdoor spa areas and garden bathtubs has gained immense popularity. While initially embraced by upscale hotels and retreats, this concept can be seamlessly replicated at home.

The KADA represents a selection of outdoor bathtubs made from natural stone Kanfanar. These bathtubs offer a luxurious and relaxing bathing experience whilst immersed in nature.

An outdoor bathtub is a lovely addition to give any garden a touch of luxury, particularly when combined with an outdoor shower. It's a clever way to create a spa-like vibe without going all out with a hot tub or pool.



Product: Outdoor bathtub KADA - ANIA
Material: Kanfanar - brushed
Code: OBKA



PRODUCT DIMENSIONS

LATIA

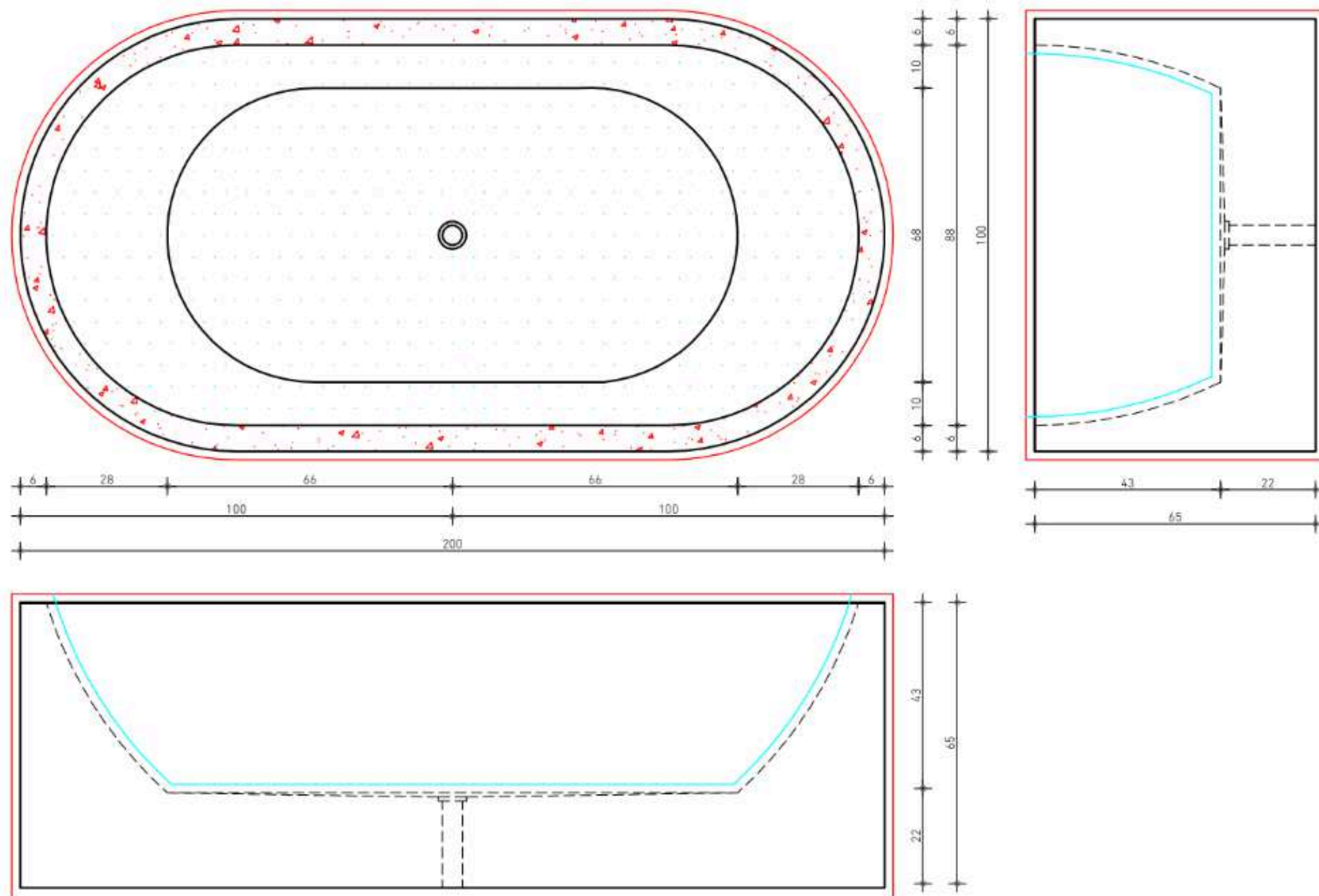

ENEA

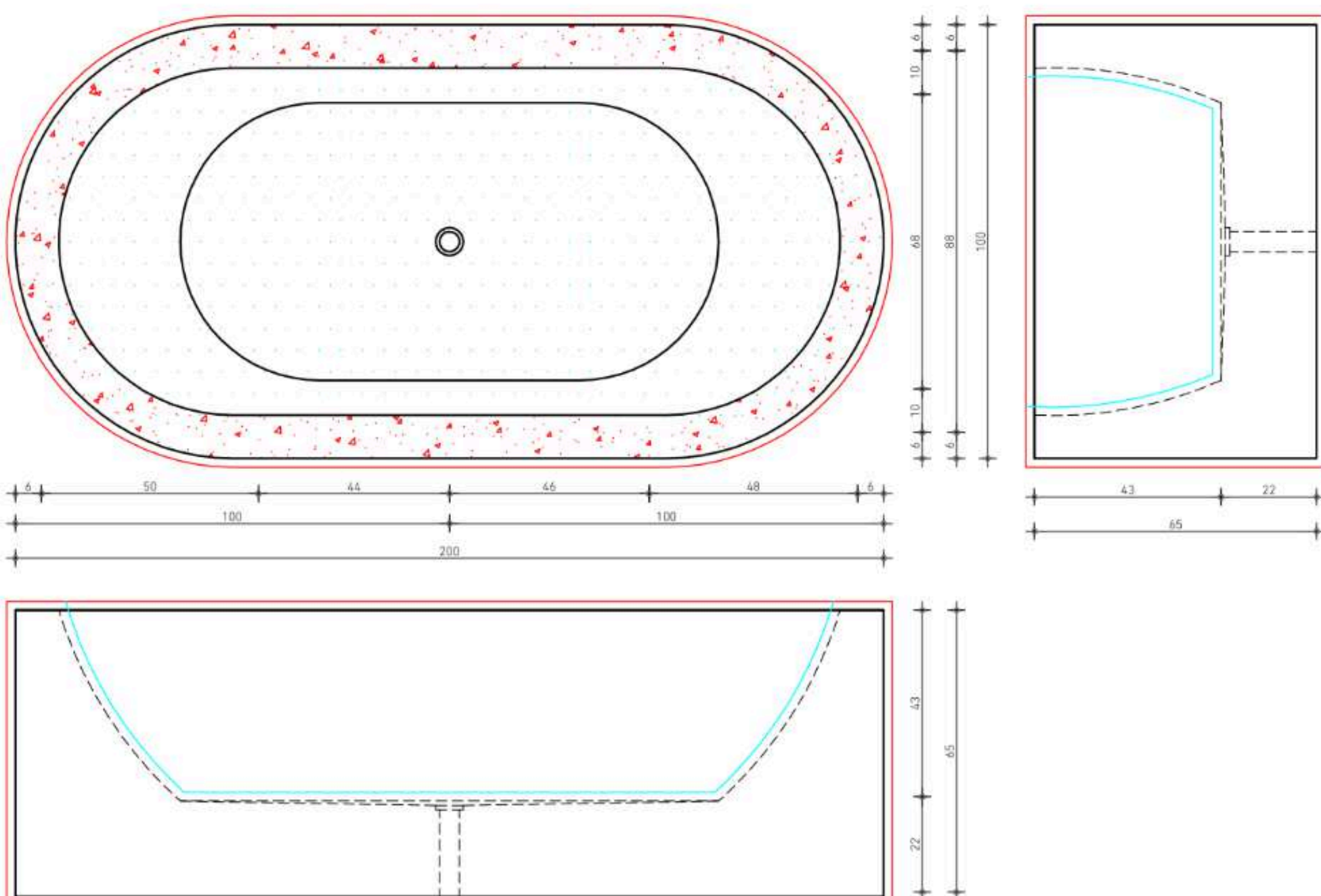

PRODUCT DIMENSIONS

ANIA

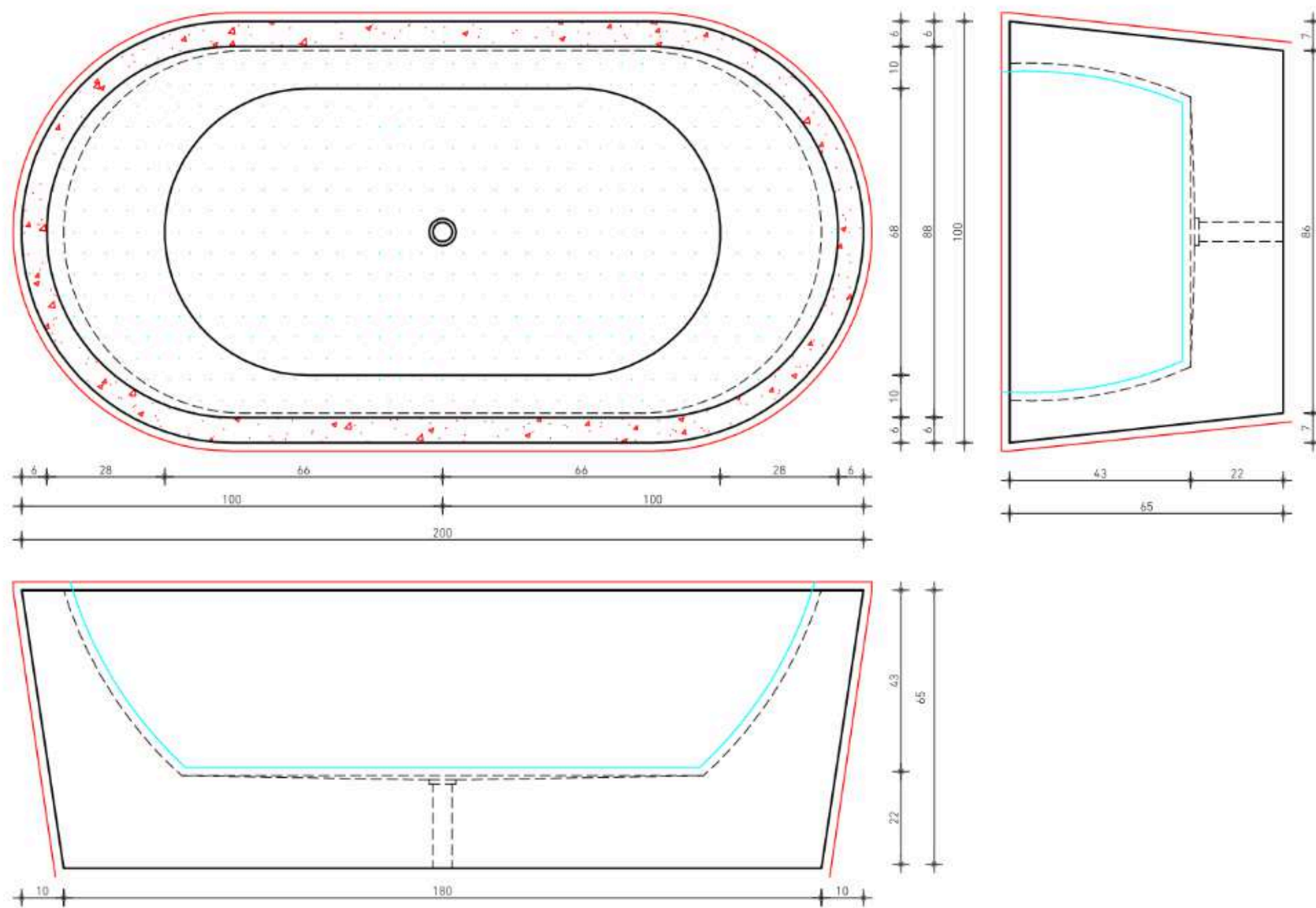

GAIA

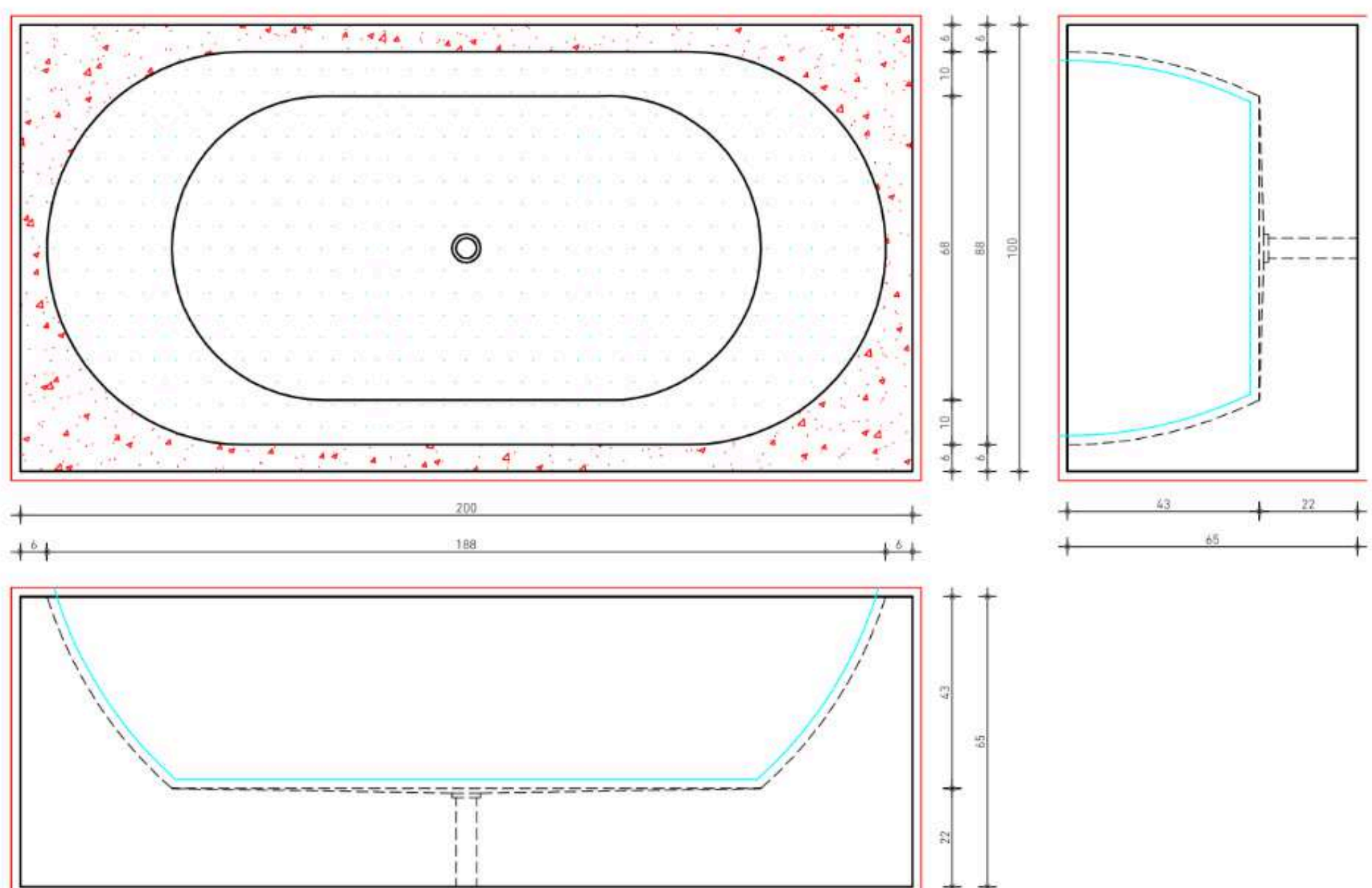

PRODUCT DIMENSIONS

LUCE

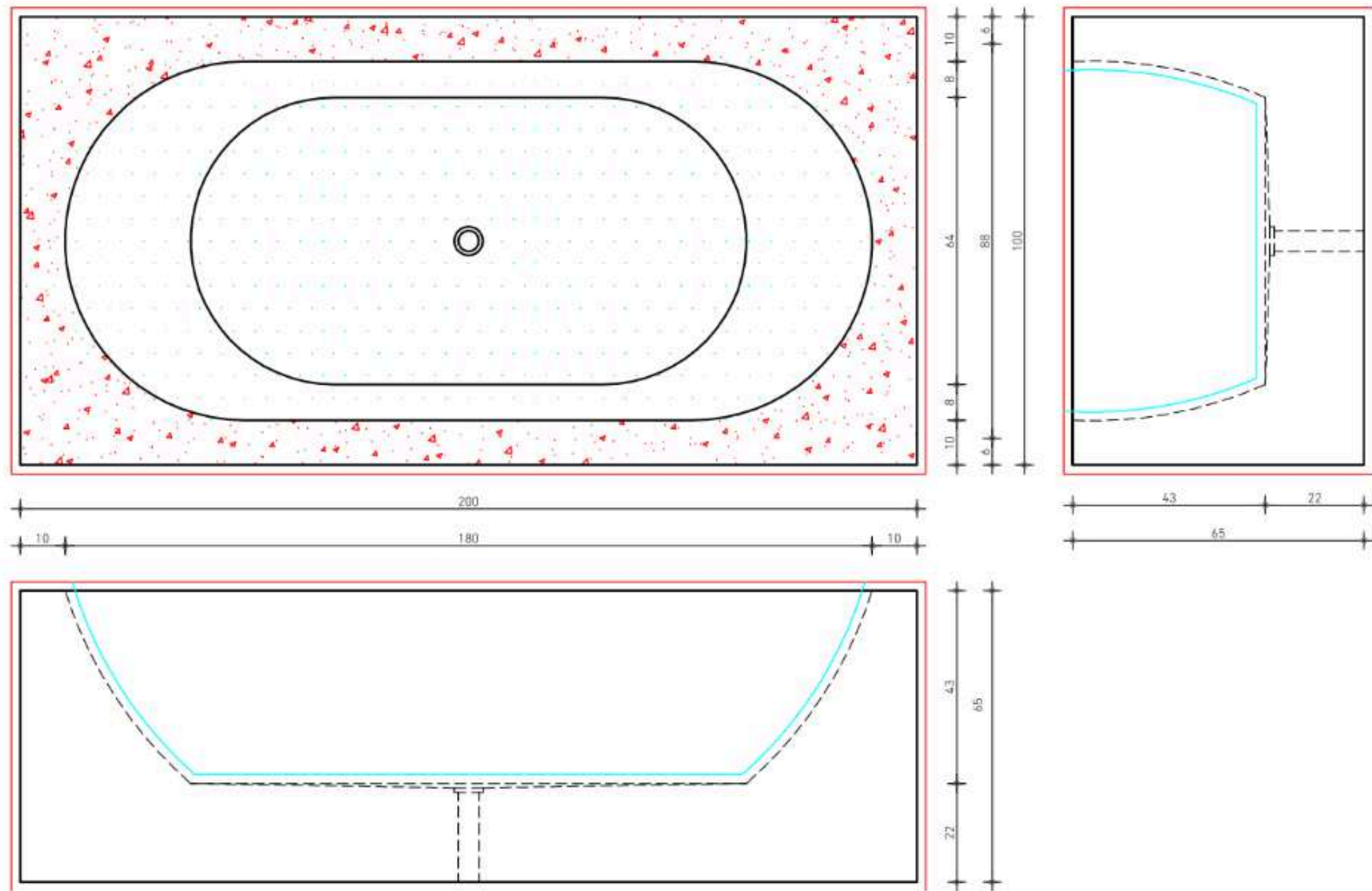

MENA

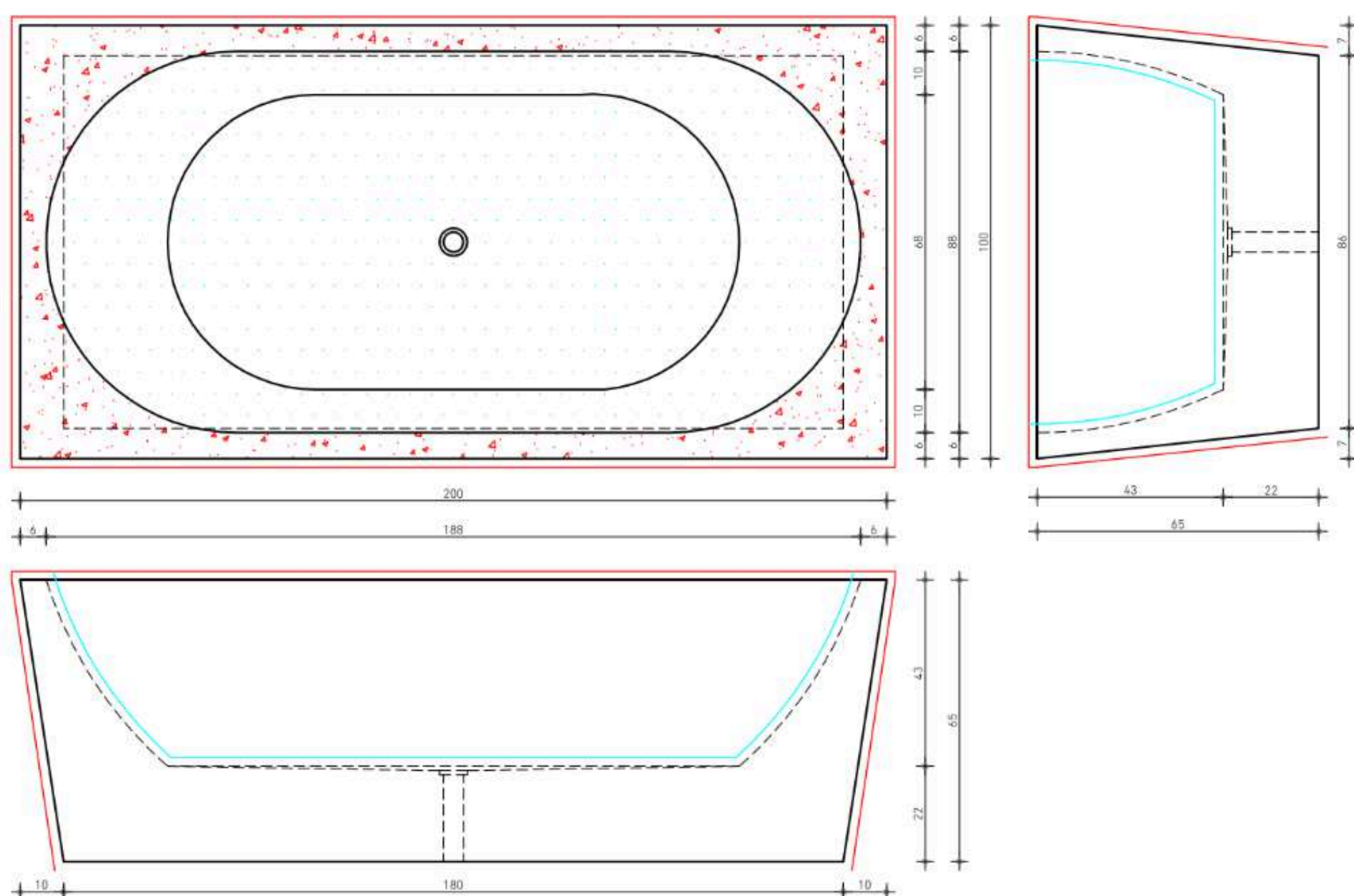



Product: Outdoor bathtub KADA - ANIA

Material: Kanfanar - brushed

Code: OBKA





Product: Outdoor bathtub KADA - GAIA
Material: Kanfanar - brushed
Code: OBKG

FUOCO ZONE

Immerse yourself in the captivating ambiance of the Fuoco Zone, where the power of fire brings people together and fuels creativity. Inspired by the age-old tradition of gathering and sharing stories around a warm and inviting flame, this zone embodies the essence of timeless connection. Our carefully curated products within the Fuoco Zone are more than just functional; they are works of art that ignite conversation and create unforgettable moments. Whether you're entertaining guests or seeking solace in quiet contemplation, these visually stunning pieces are designed to enhance your experience and elevate any setting. Let the Fuoco Zone become the heart of your outdoor space, where warmth, beauty, and unforgettable memories come to life.



GARDENZIO



TA

Carefully selected materials and multiple design options is what makes the GARDENZIO range of outdoor kitchens so unique.

Our kitchens will enhance any outdoor space, serving as the focal point of your alfresco dining encounters; offering a harmonious design that accommodates diverse applications.

Developed in partnership with Gardenzio - Outdoor Living.

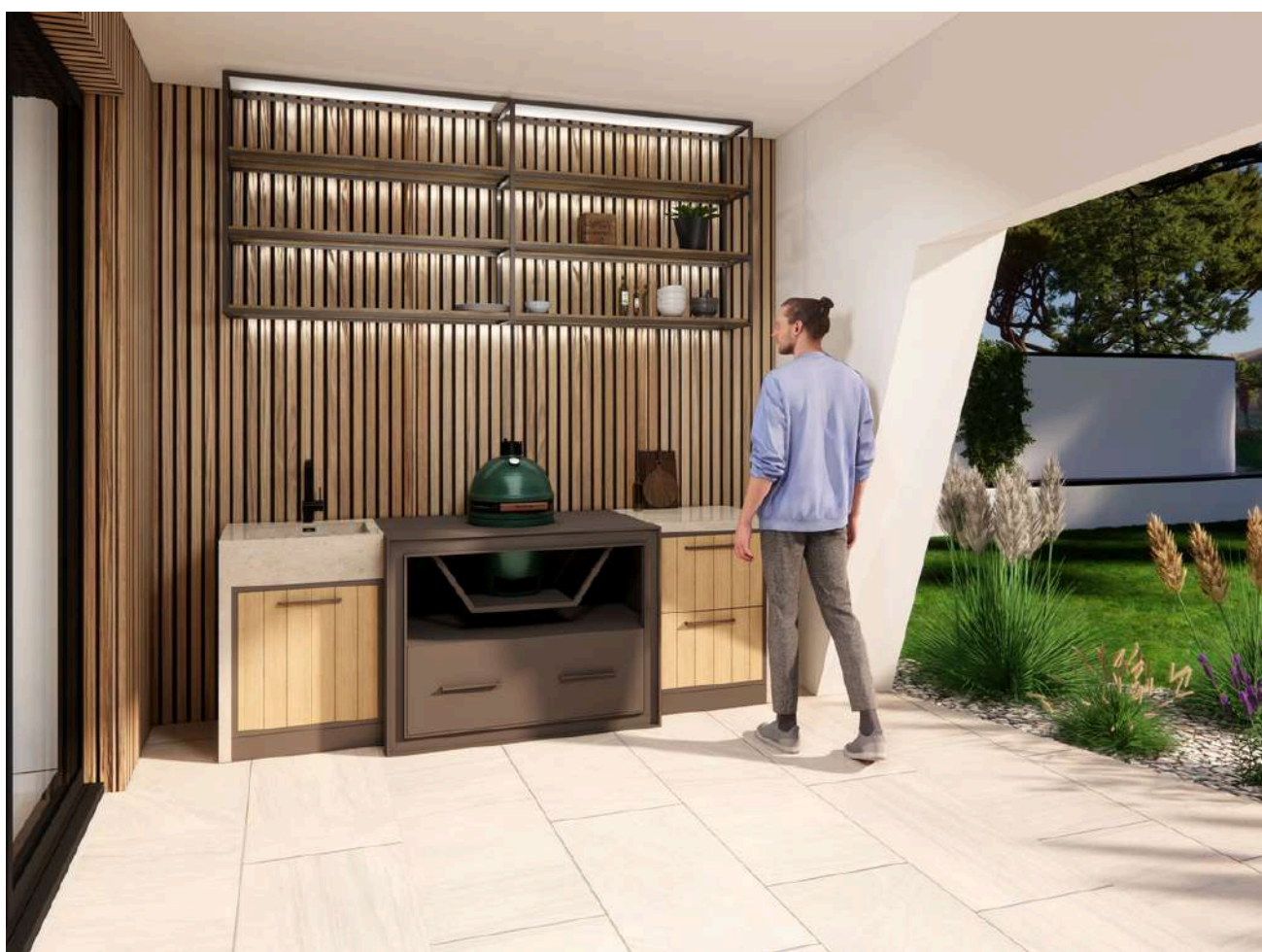

Product: Outdoor kitchen *COMPATTO*
Code: ROKC75KANMOKDUB



Product: Outdoor kitchen *COMPATTO*
Code: EOKC75GOL20LATDUB



WOOD



European Oak / Brazilian IPE / Siberian Larch

** In addition, we offer an array of HPL finishes made by Fundermax as a non-wood alternative.*

STONE

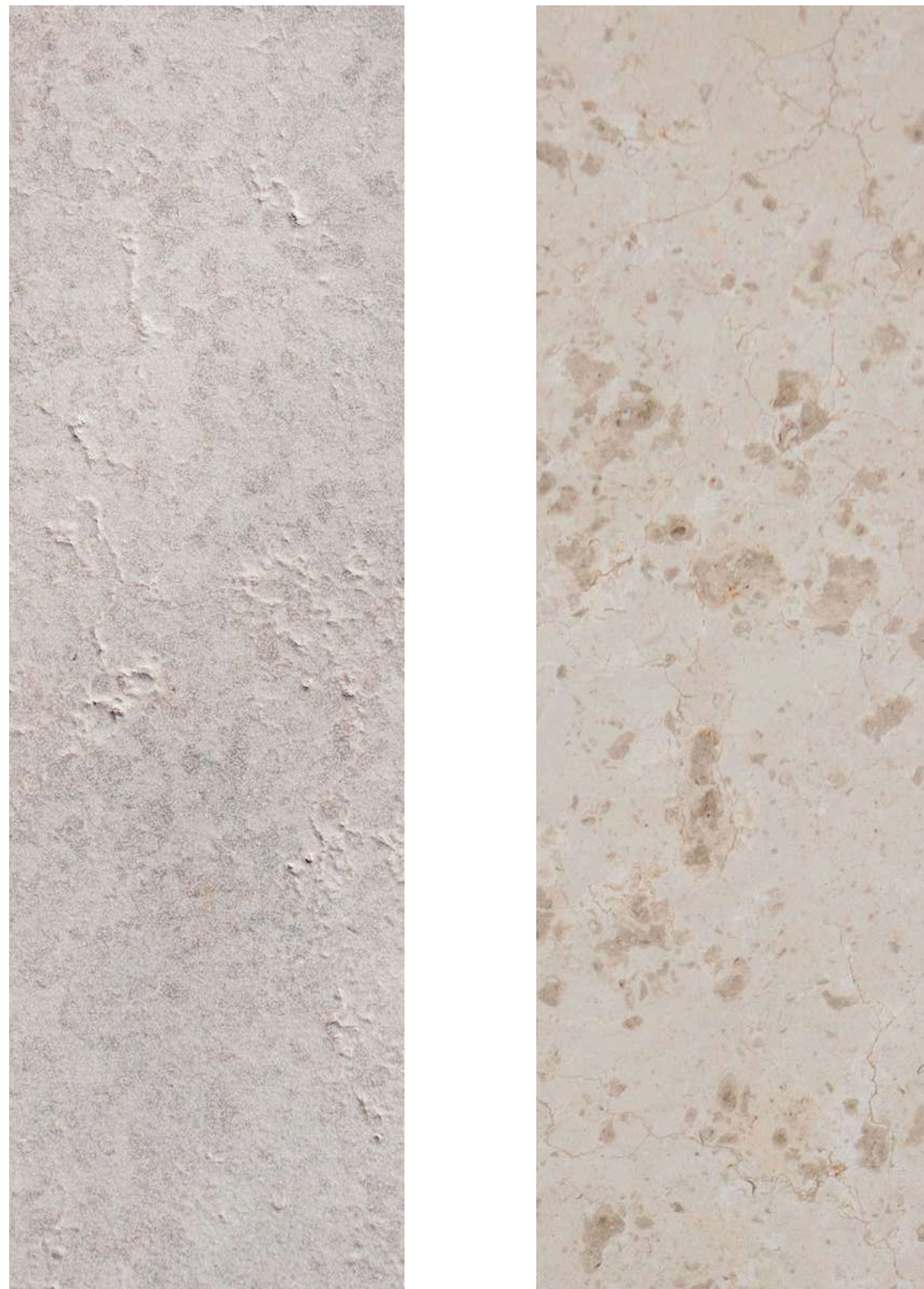

Kanfanar: Sandblasted+brushed / Honed

**In addition, we offer Nero Assoluto, Steel Gray, Vizag Blue, Verde Marina and THE TOP collection by Marazzi as a non-stone alternative.*

METAL

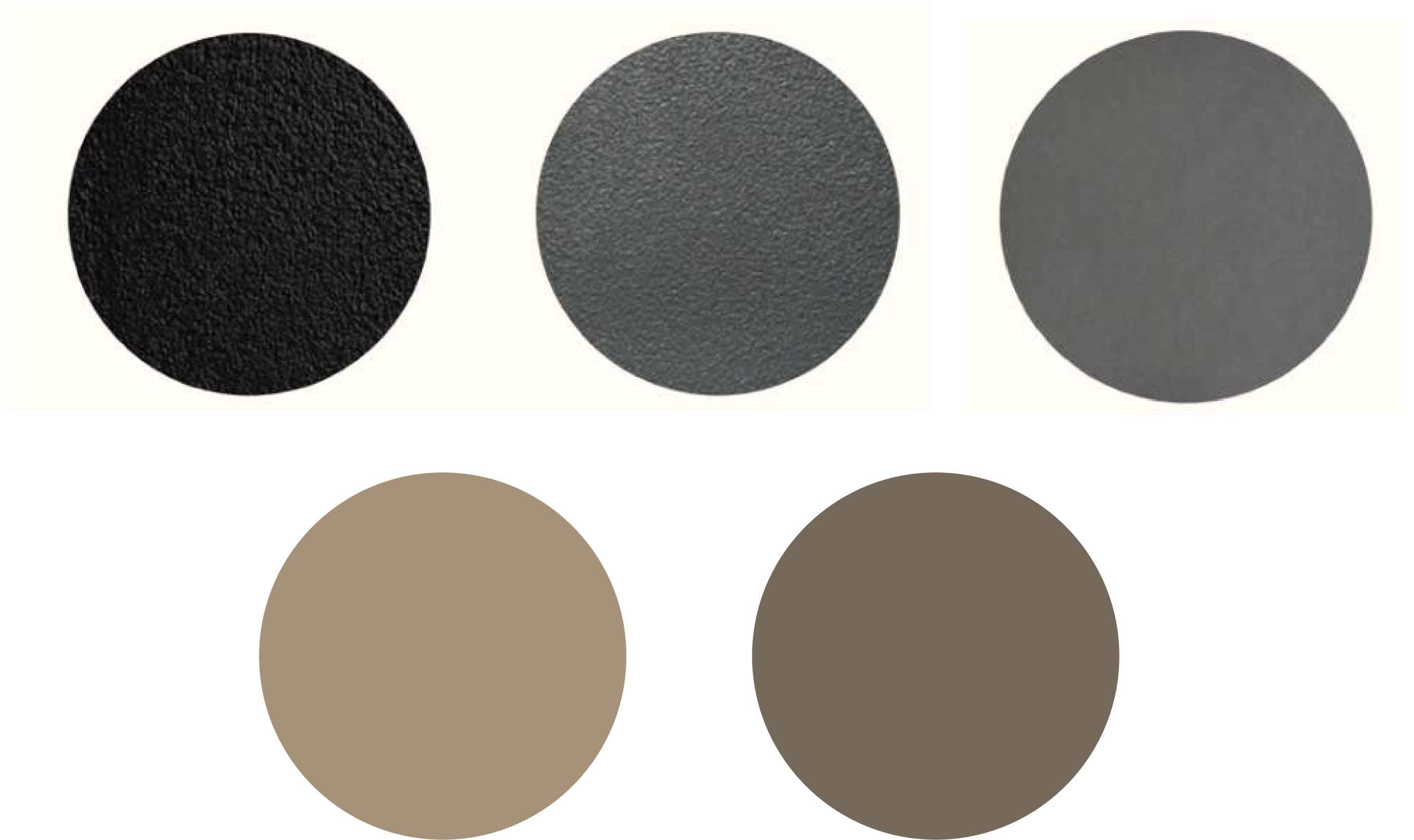

*Black / Anthracite / Gray
Latte / Mocha*

** The metal construction is powder-coated and is currently available in five colors.*

PRODUCT DIMENSIONS

ROBUSTA - 75

COMPATTO

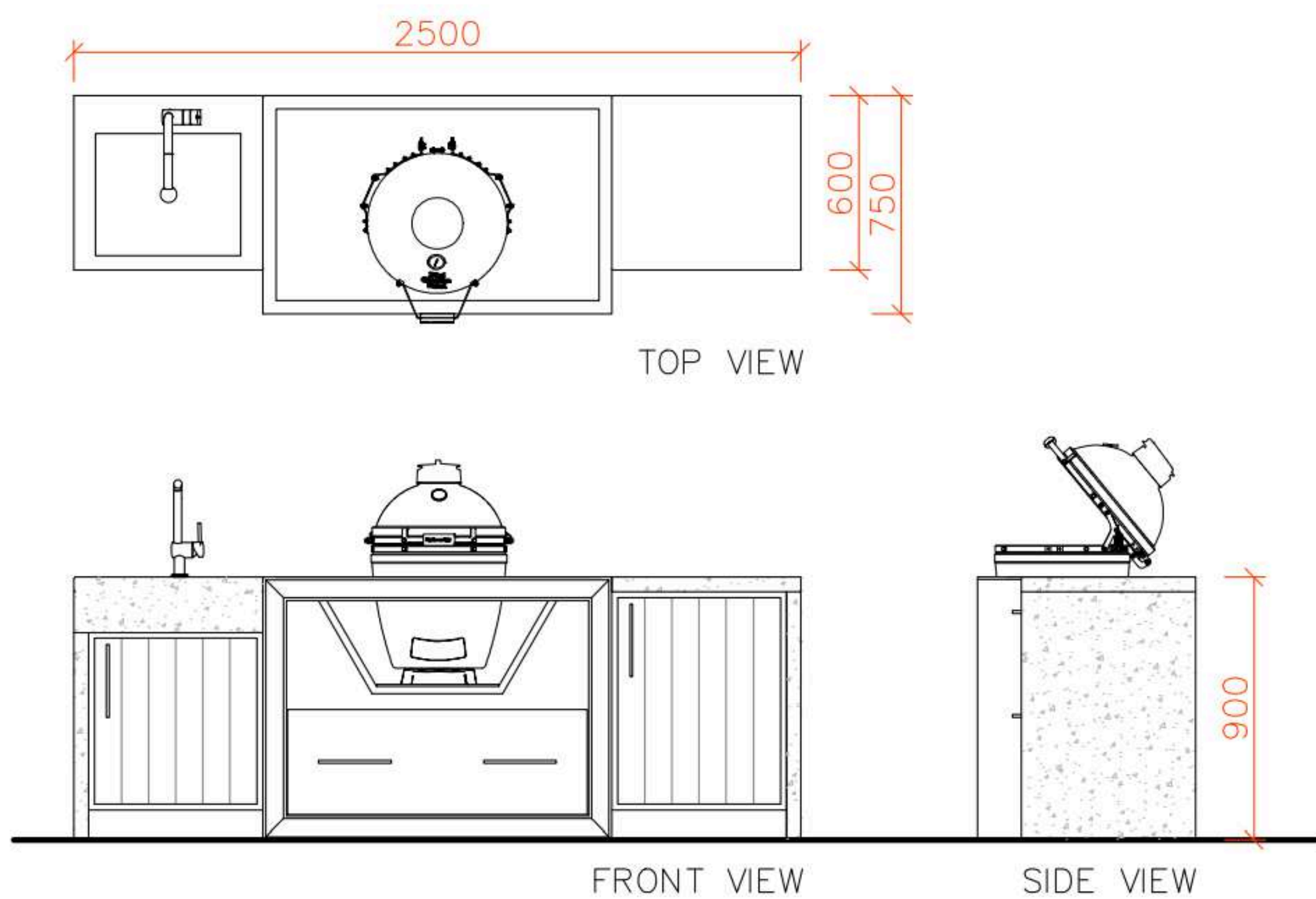

*Kanfanar stone worktop (50 mm), European Oak wood cupboards,
Big Green Egg (Size M) and Kanfanar stone sink*

PRODUCT DIMENSIONS

ROBUSTA - 75

MEDIO

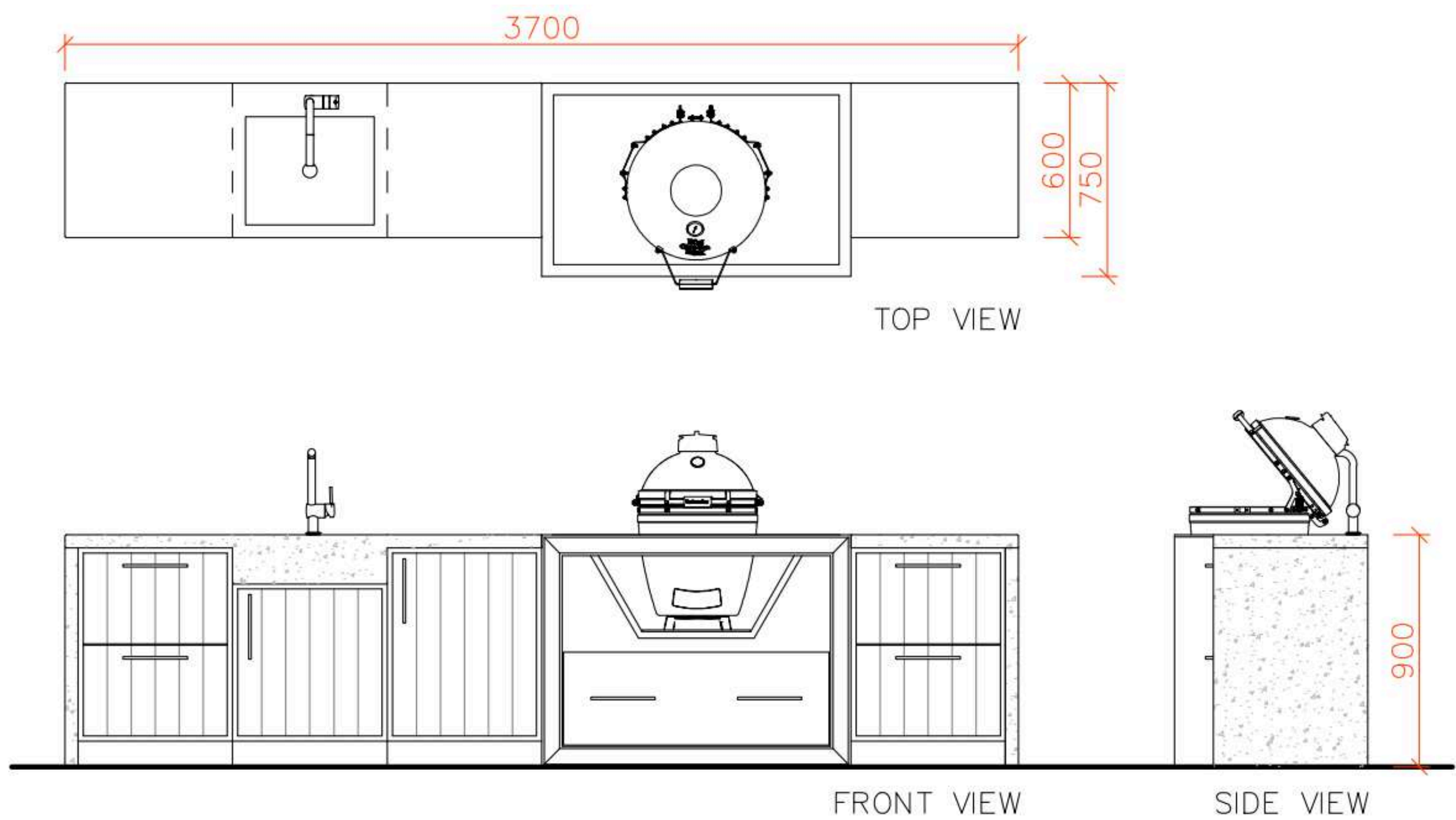

*Kanfanaar stone worktop (50 mm), European Oak wood cupboards,
Big Green Egg (size M) and Kanfanaar stone sink*

PRODUCT DIMENSIONS

ROBUSTA - 75

GRANDE

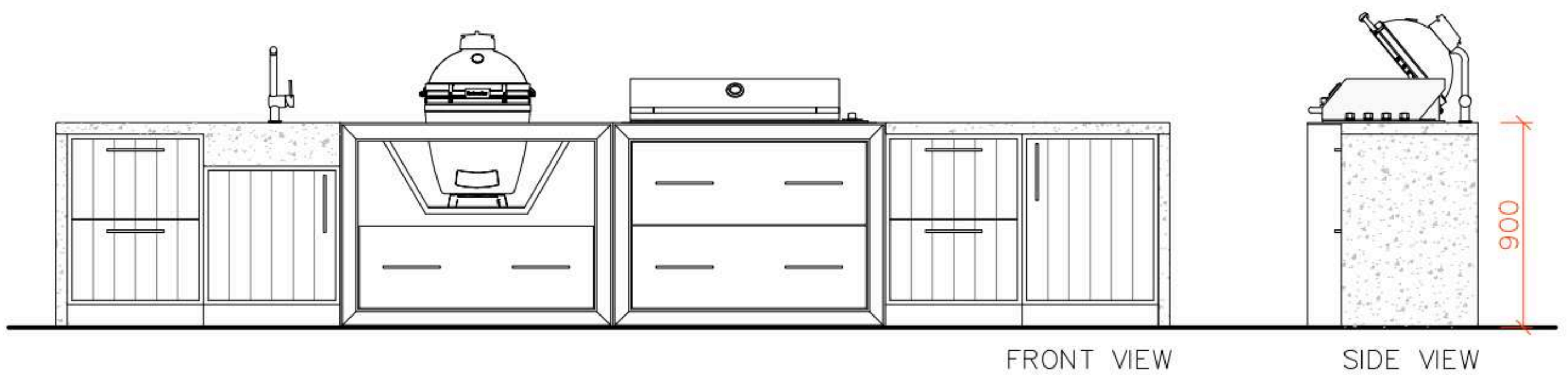
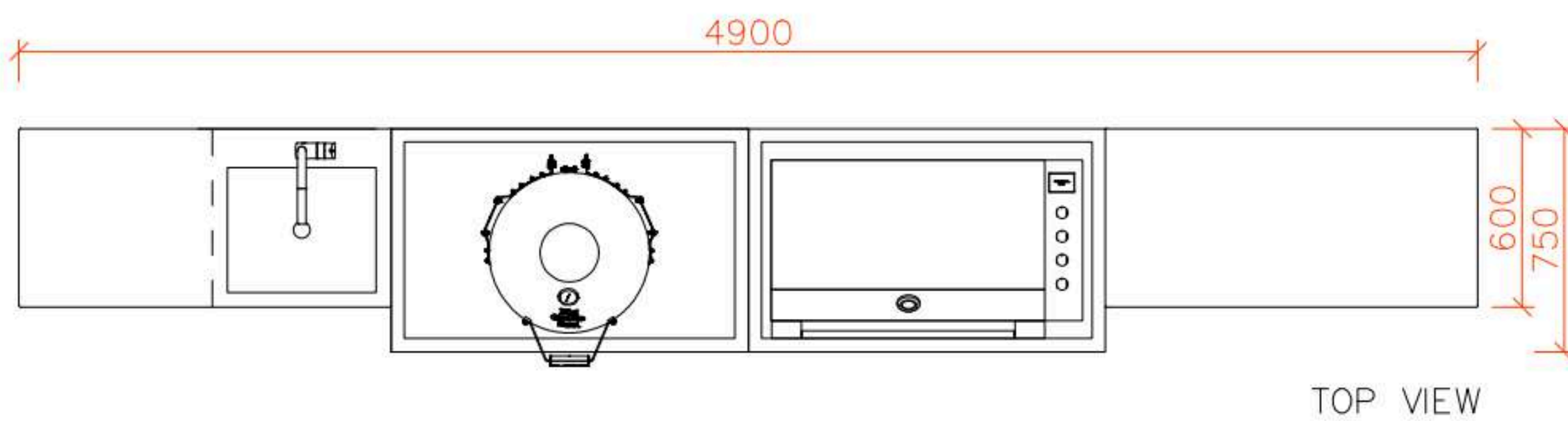

*Kanfanas stone worktop (50 mm), European Oak wood cupboards,
Big Green Egg (size M), Indu + Gazzgrill and Kanfanar stone sink*

PRODUCT DIMENSIONS

ELEGANTE

COMPATTO '90'

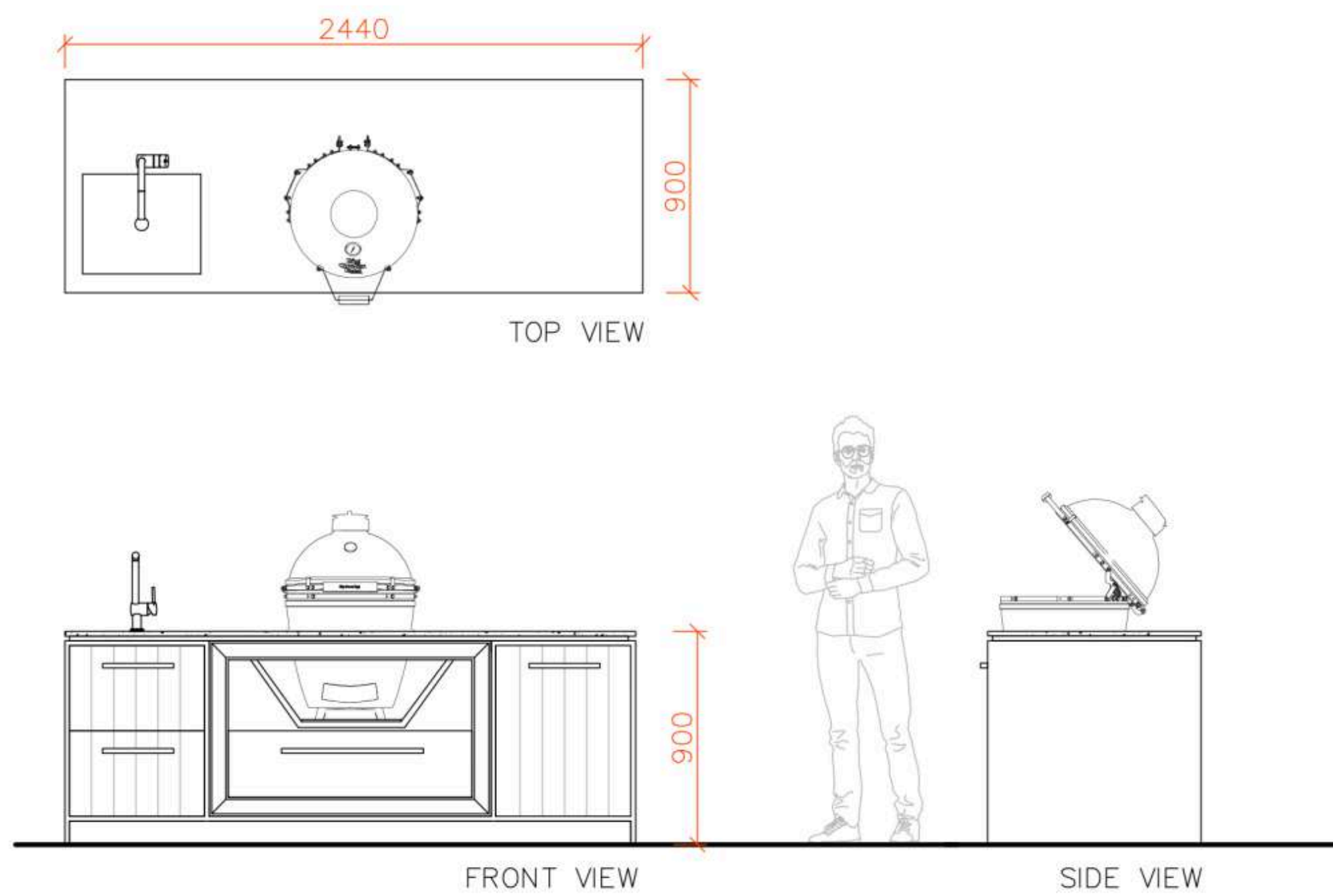

*Kanfana stone worktop (30 mm), European Oak wood cupboards,
Big Green Egg (size M) and Kanfana stone sink*

PRODUCT DIMENSIONS

ELEGANTE

MEDIO '90'

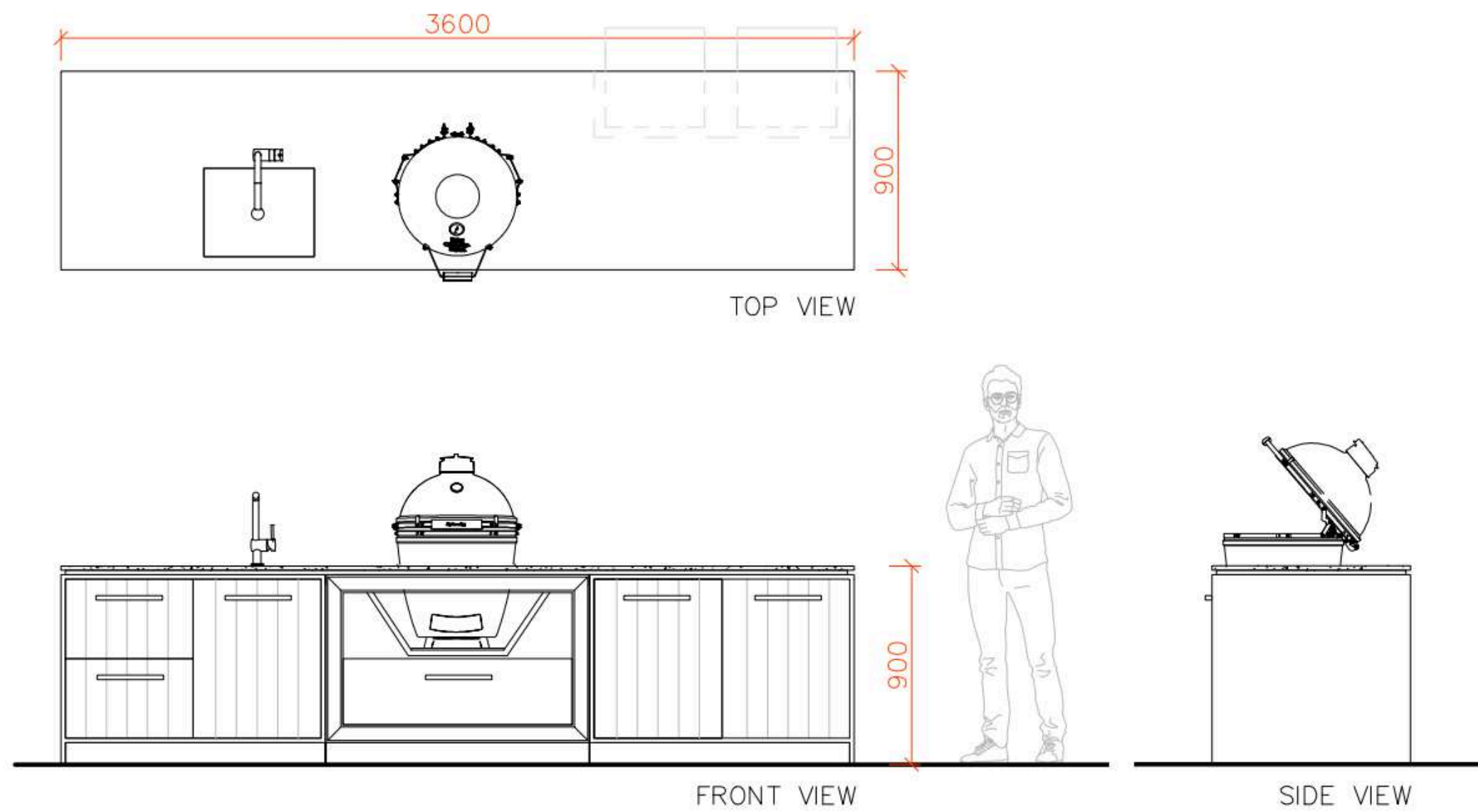

MEDIO '120'

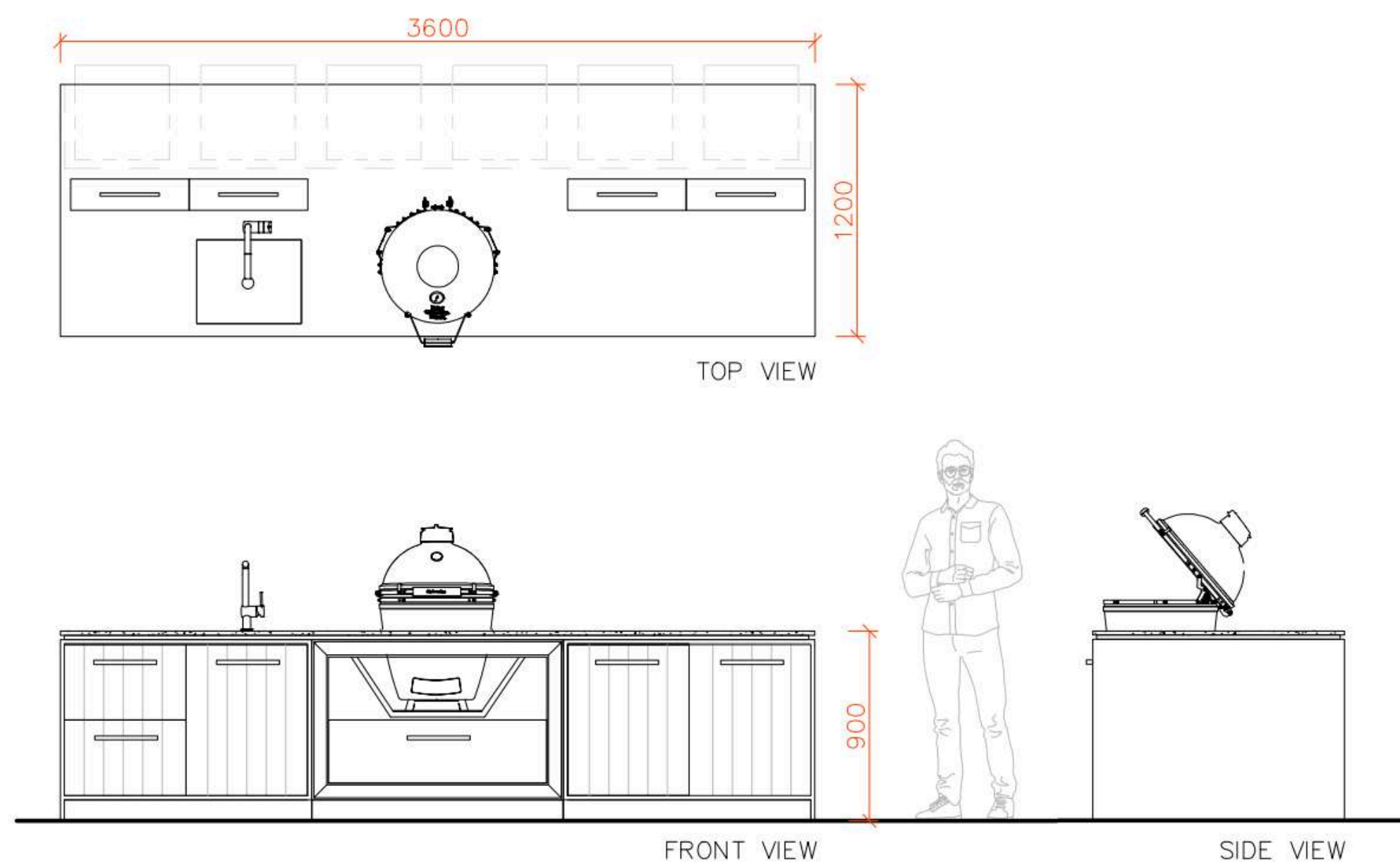

*Kanfanaar stone worktop (30 mm), European Oak wood cupboards,
Big Green Egg (size M) and Kanfanaar stone sink*

PRODUCT DIMENSIONS

ELEGANTE

GRANDE '90'

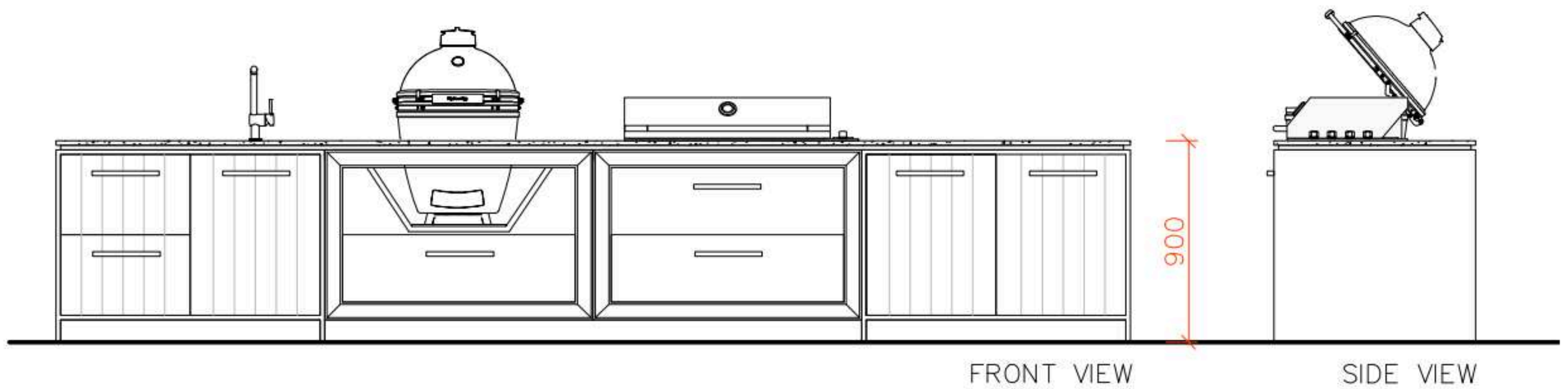
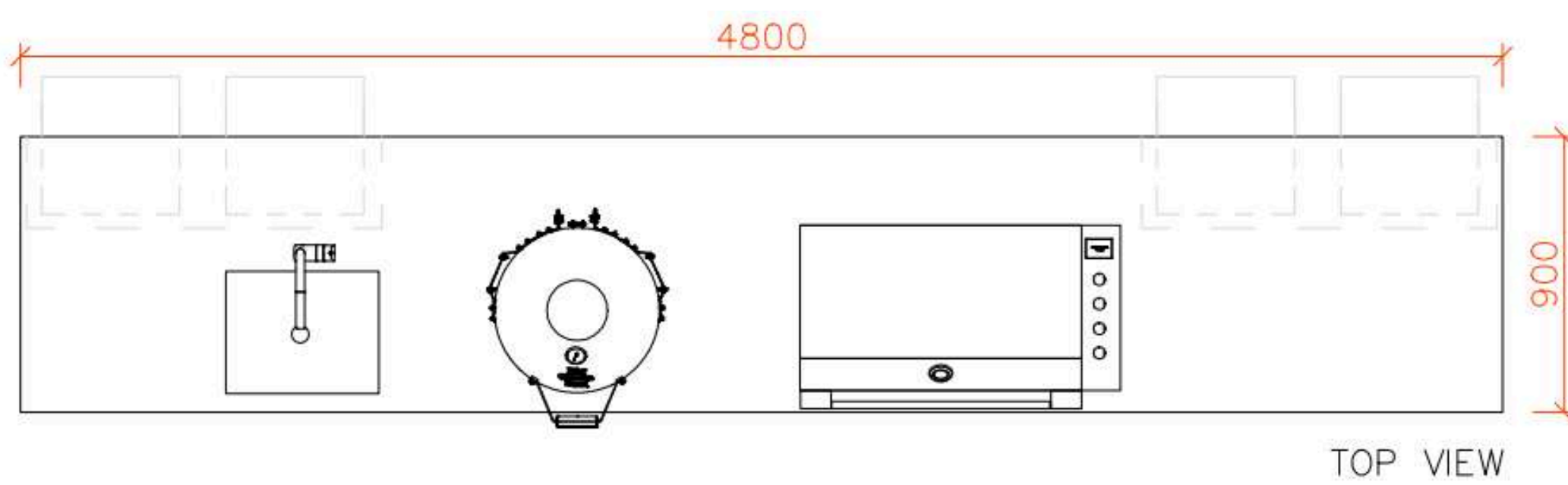

*Kanfana stone worktop (30 mm), European Oak wood cupboards,
Big Green Egg (size M), Indu+Gazzgrill and Kanfana stone sink*

PRODUCT DIMENSIONS

ELEGANTE

G2 - GRANDE '120'

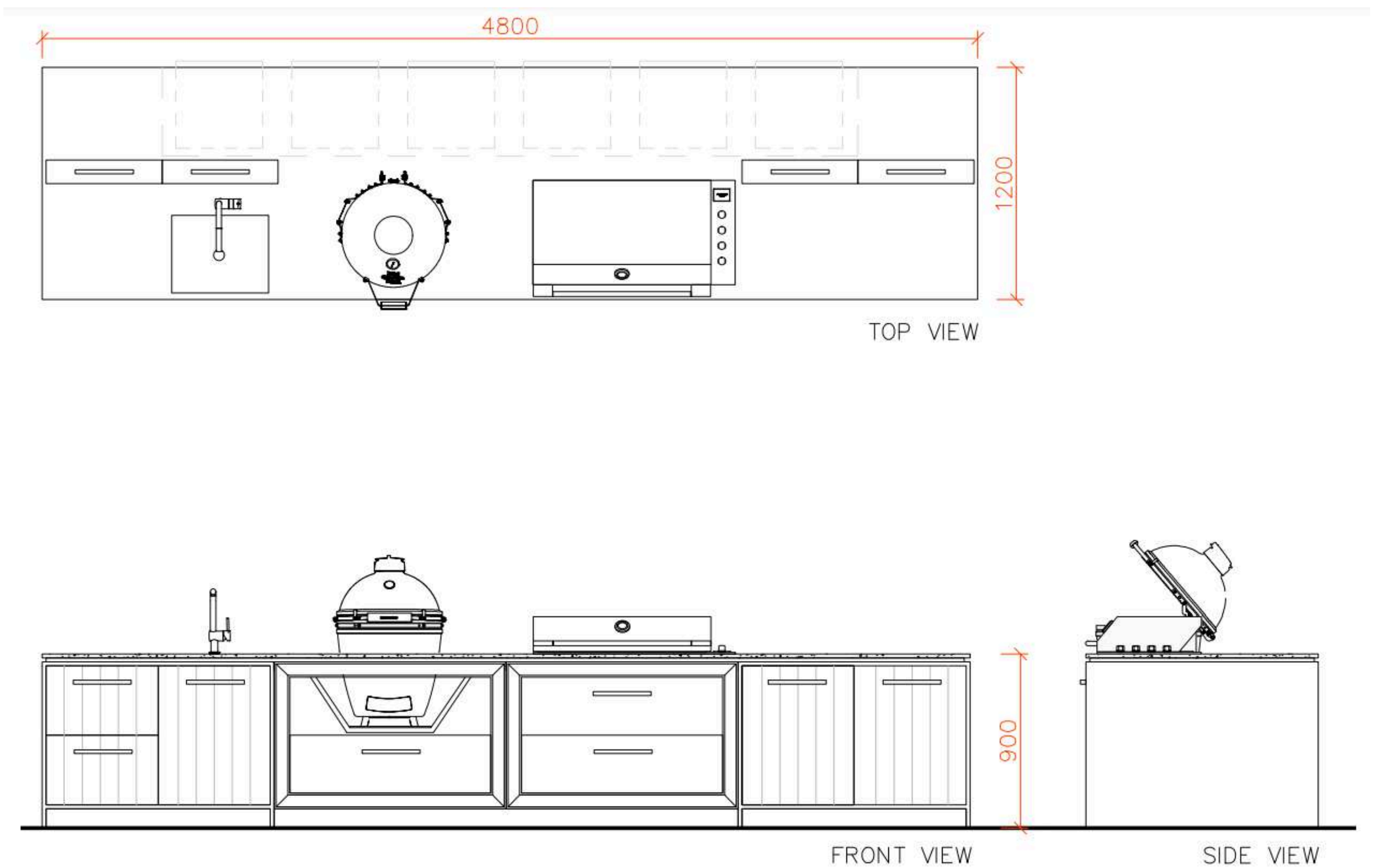

*Kanfanas stone worktop (30 mm), European Oak wood cupboards,
Big Green Egg (size M), Indu + Gazzgrill and Kanfanar stone sink*

APPLIANCES



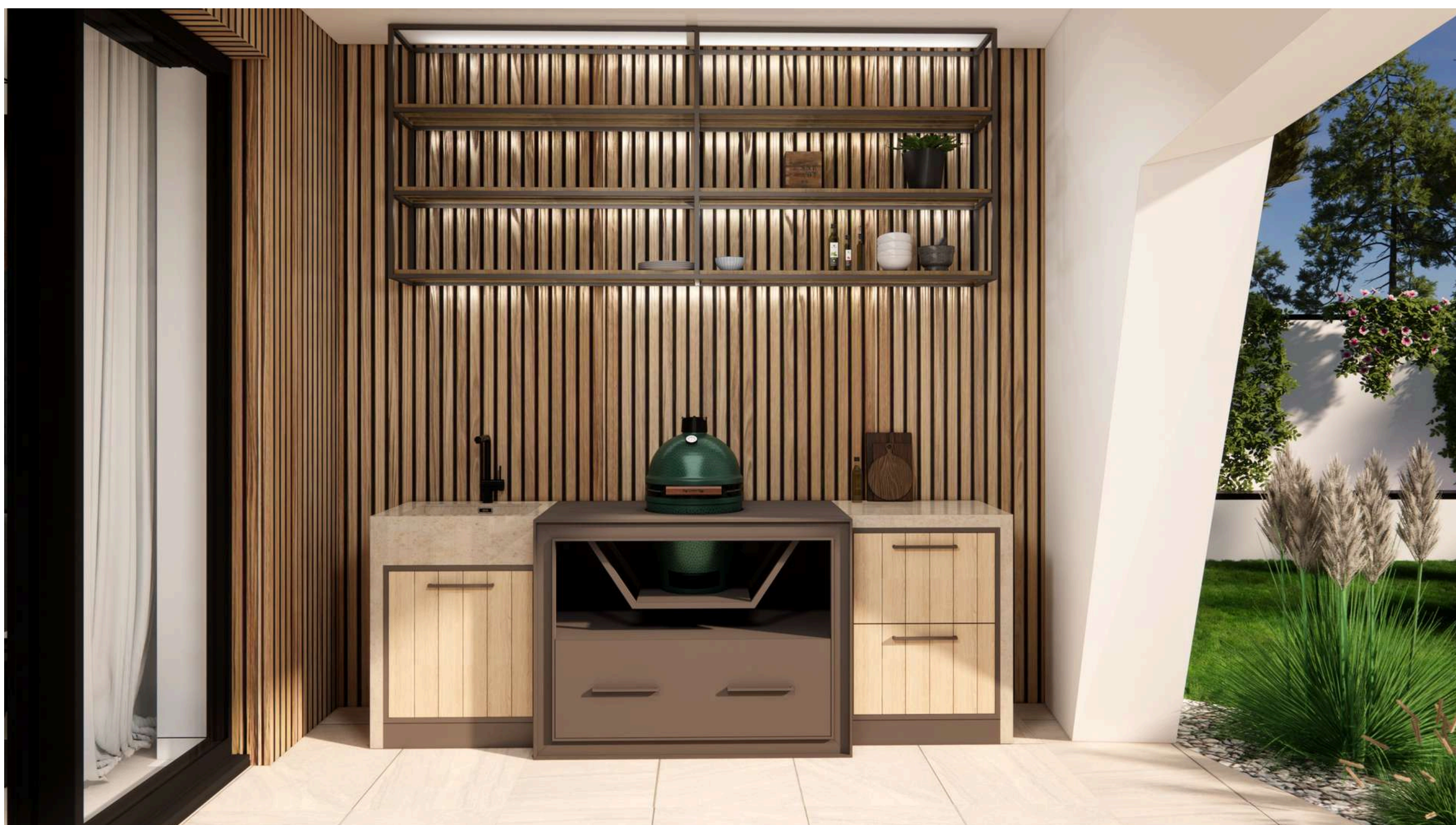

Product: Outdoor kitchen *COMPATTO*
Code: ROKC75KANMOKDUB





Product: Outdoor kitchen *GRANDE*
Code: ROKG75STEMANTHPL



Product: Outdoor kitchen *MEDIO*
Code: ROKM75NERANTIFE

KAMIN



KAMIN, an Istrian word for fireplace, represents the heritage of our premium-designed outdoor fire pits. Unique surfaces for unique gardens.

Experience the harmonious fusion of elegance and warmth with our fire pit, elevating your surroundings with its stunning aesthetics that ignite a sublime sense of serenity and charm.

The base of the fire pit is crafted from authentic Istrian stone, Kanfanar, which offers a variety of finishes.



Product: Outdoor fire pit KAMIN
Material: Kanfanar - polished
Code: KAMKP

Created by nature, made by people.





LIMESTONE KANFANAR

absorption 0.68 %
compressive strength 186.00 MPA
flexural strength 9.6 MPa
abrasion resistance 14



Polished / Bush hammered +brushed / Sandblasted+brushed / Rigato / Flamed+brushed

PRODUCT DIMENSIONS

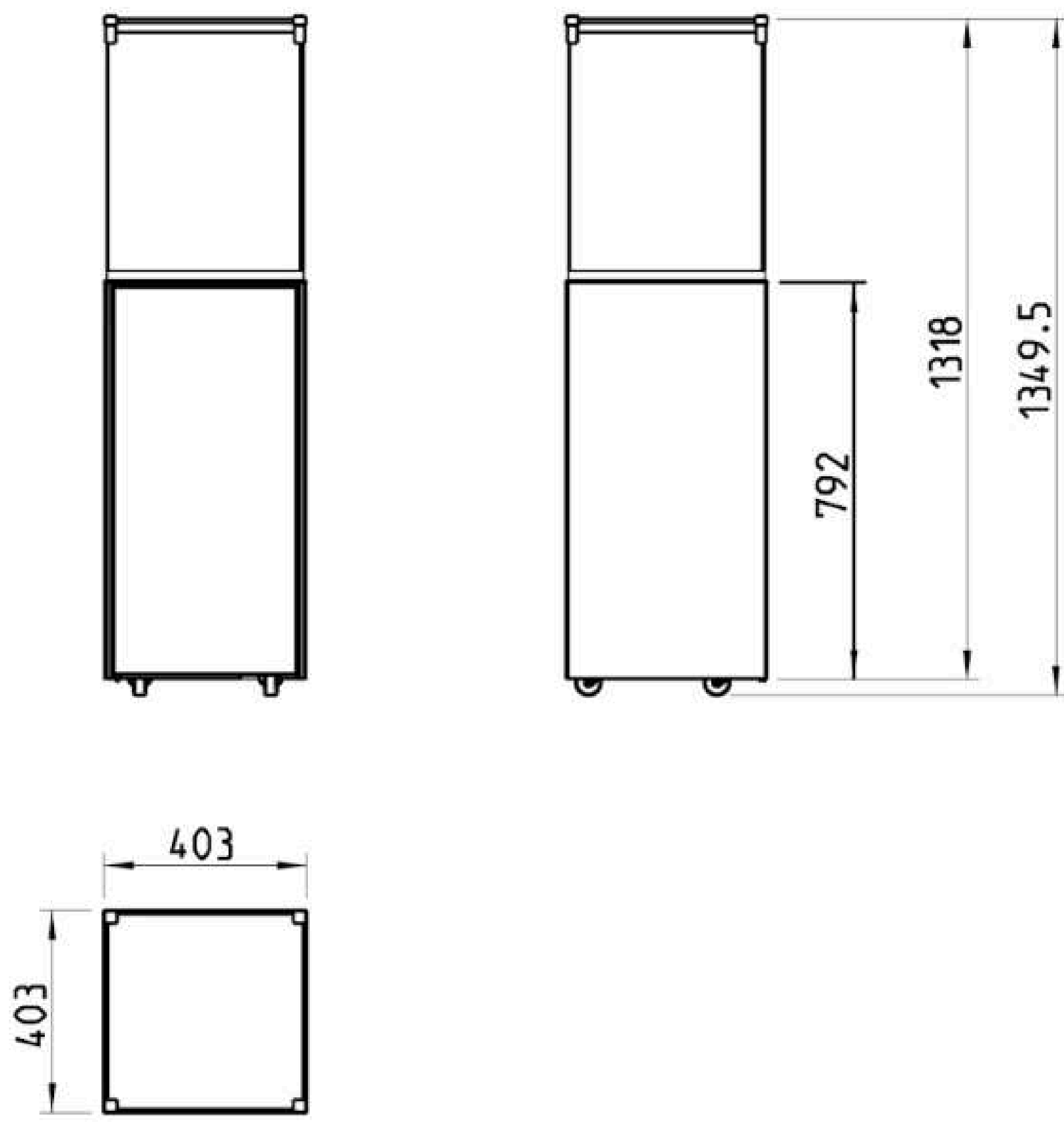

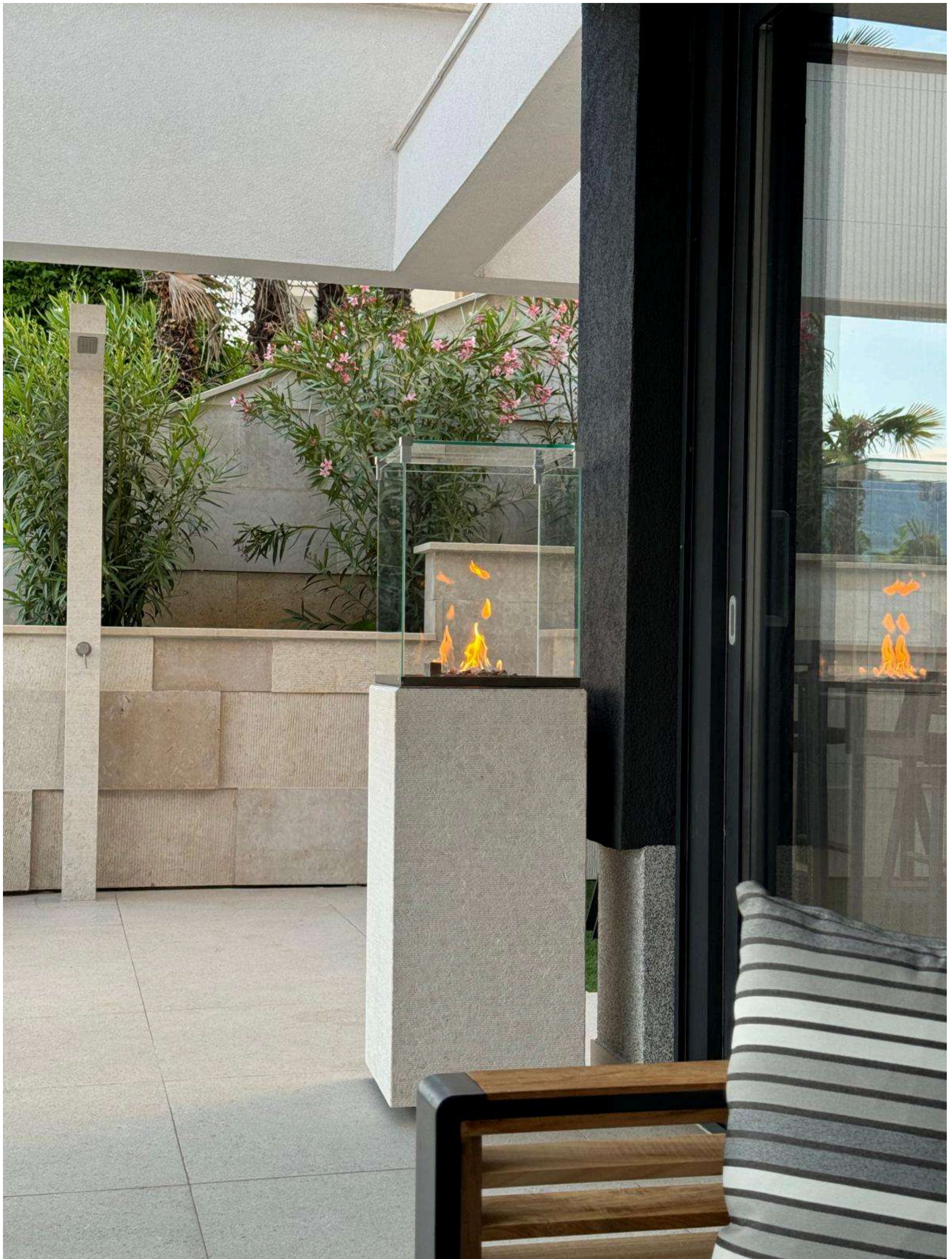

ARIA ZONE

Aria Zone offers an idyllic sanctuary from the demands of everyday life. Step into a world of serenity and tranquility as you explore our carefully curated range of products designed to help you unwind in the great outdoors. Whether you seek a peaceful spot for meditation, a cozy corner to delve into your favorite book, or a space to create lasting memories with your loved ones, the Aria Zone welcomes you with open arms, inviting you to indulge in moments of pure bliss.



Envision a place where time slows down, and your worries effortlessly drift away. The Aria Zone is that perfect haven, crafted to provide an escape from the stresses of daily life. As you relax and recharge in this oasis of tranquility, you'll find yourself enveloped in a sense of calm and rejuvenation. With the Aria Zone, you can savor every precious moment, cherishing the simple joys of life, like drinking coffee or nurturing the plants and creating cherished memories that will last a lifetime. Indulge yourself and experience the true essence of relaxation amidst the captivating allure of the Aria Zone.

PONTE



Ponte is a part of KORTA collections, serving as both a functional and decorative element – either a coffee table to place between sun loungers or a side table of an outdoor bathroom. Following the clean lines of the Marbella and Odino showers, it unobtrusively serves the purpose and elevates the aesthetic perception of the space.



Product: Coffee table *Ponte*
 Material: Marazzi Sahara Noir
 Code: CTPLMSN/CTPXLMSN

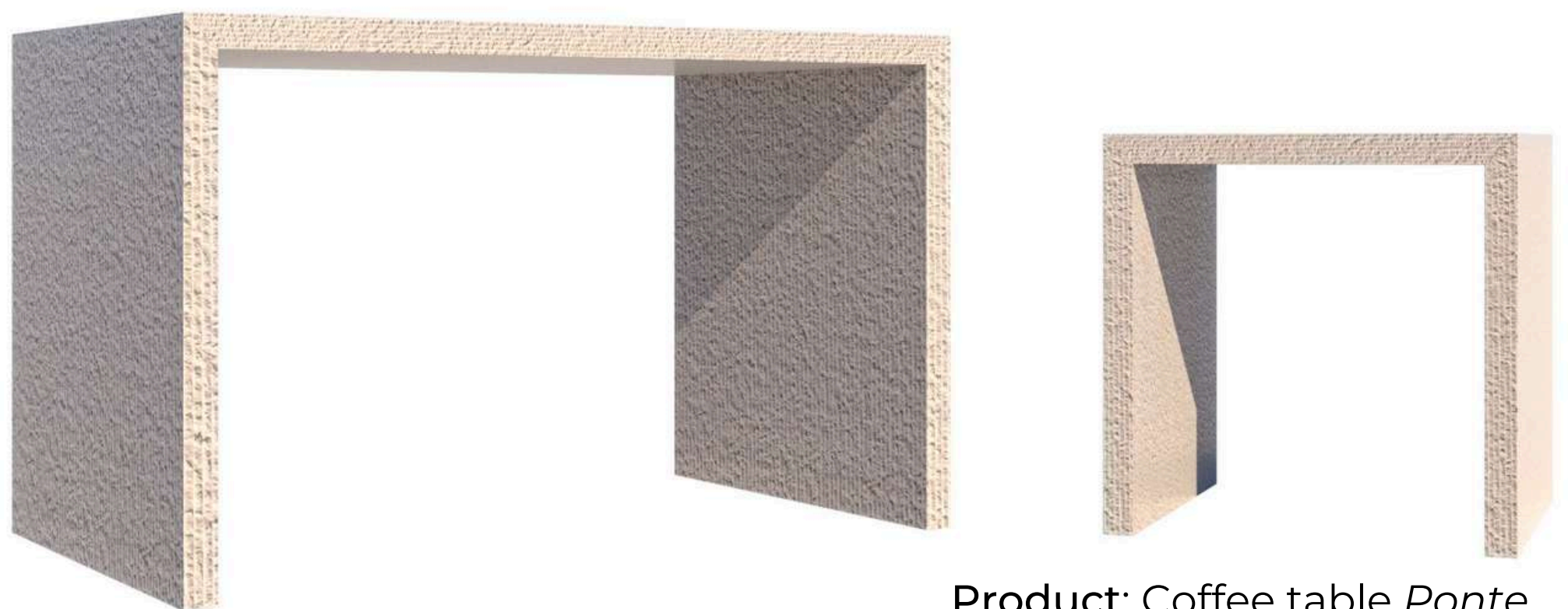

Product: Coffee table *Ponte*
 Material: Kanfanar - rigato
 Code: CTPLKR/CTPXLKR



Product: Coffee table *Ponte*
Material: Kanfanar - sandblasted + brushed
Code: CTPLKSB/CTPXLKSB



Product: Coffee table *Ponte*
Material: Marazzi Saint Laurent
Code: CTPLMSL/CTPXLMSL

PRODUCT DIMENSIONS

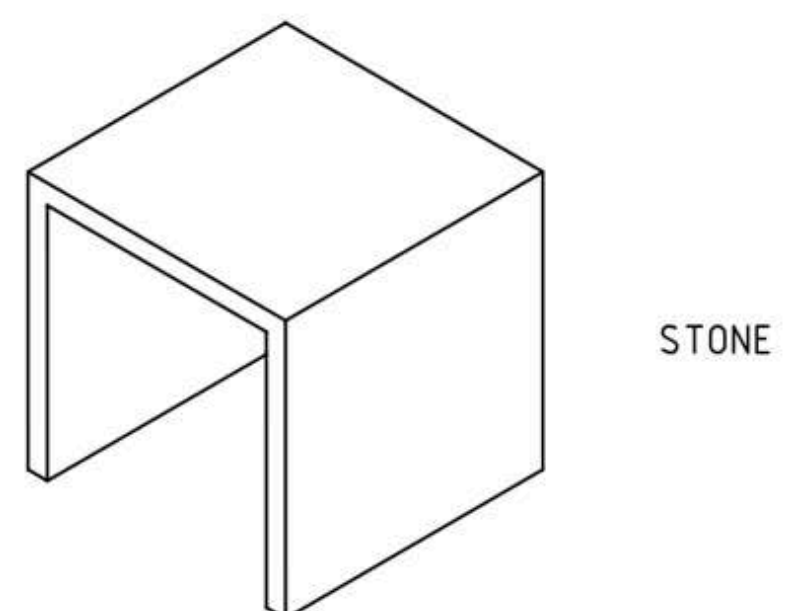
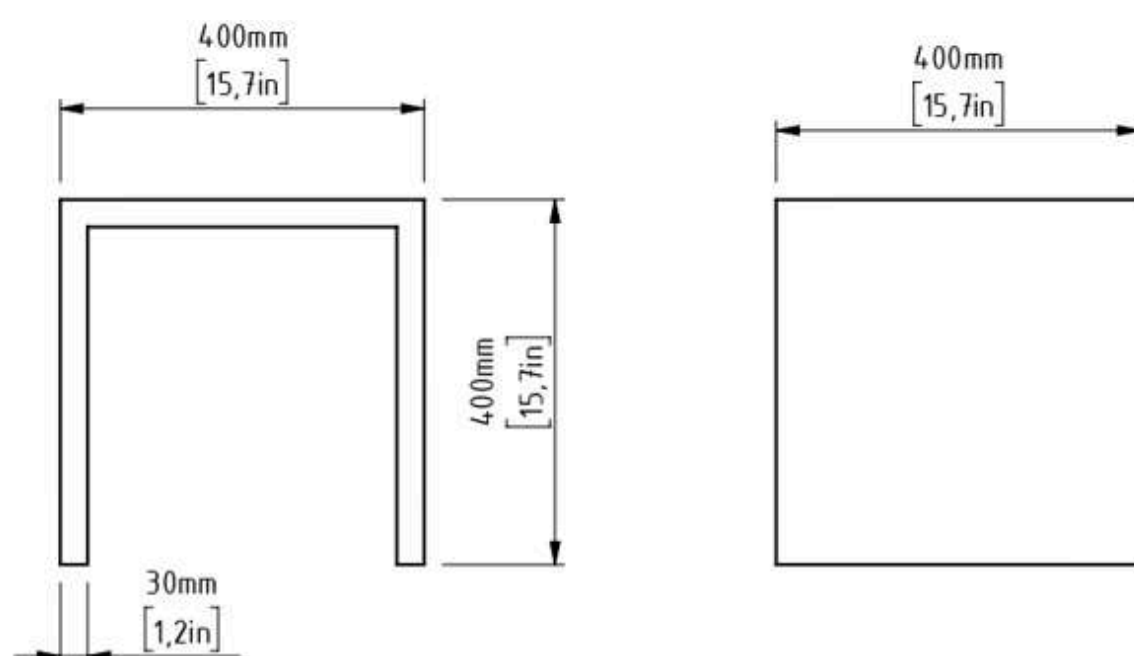
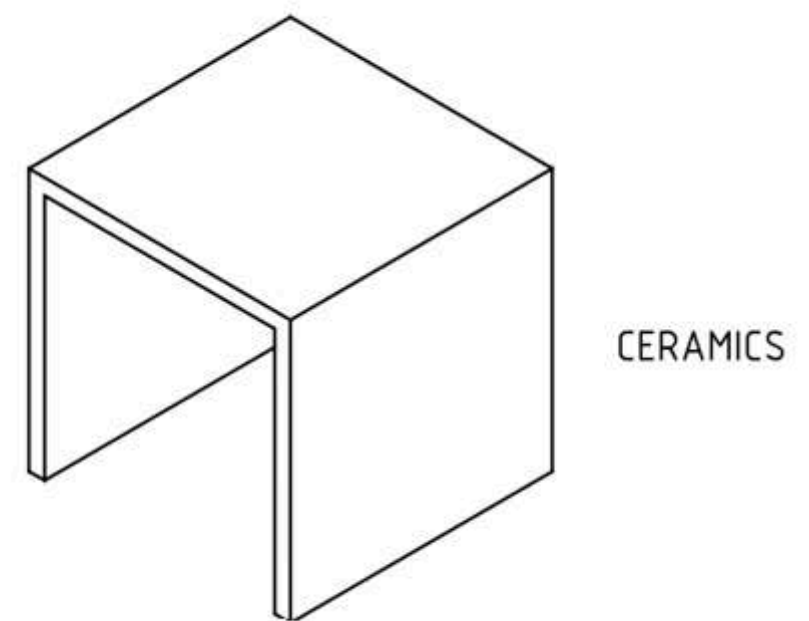
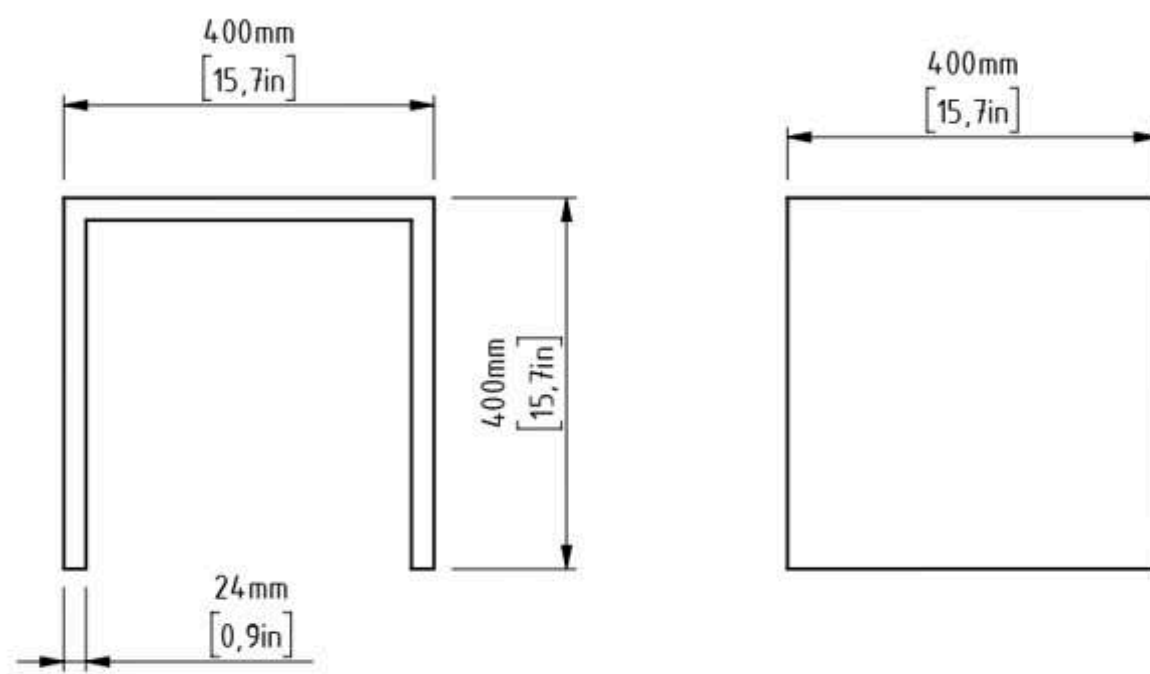
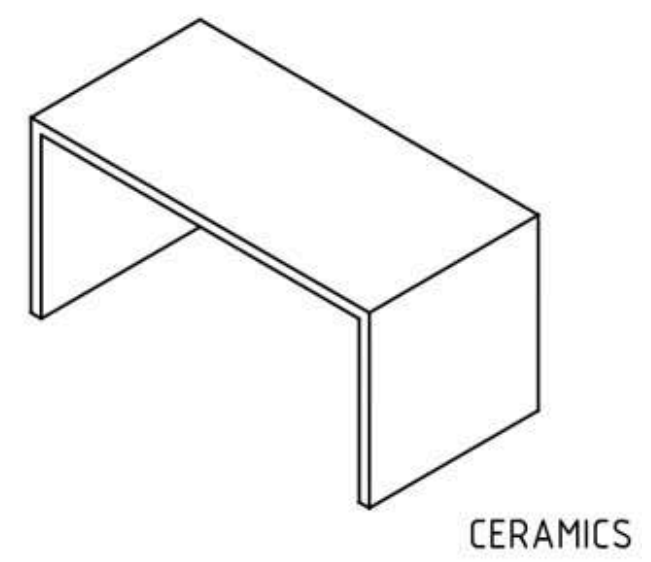
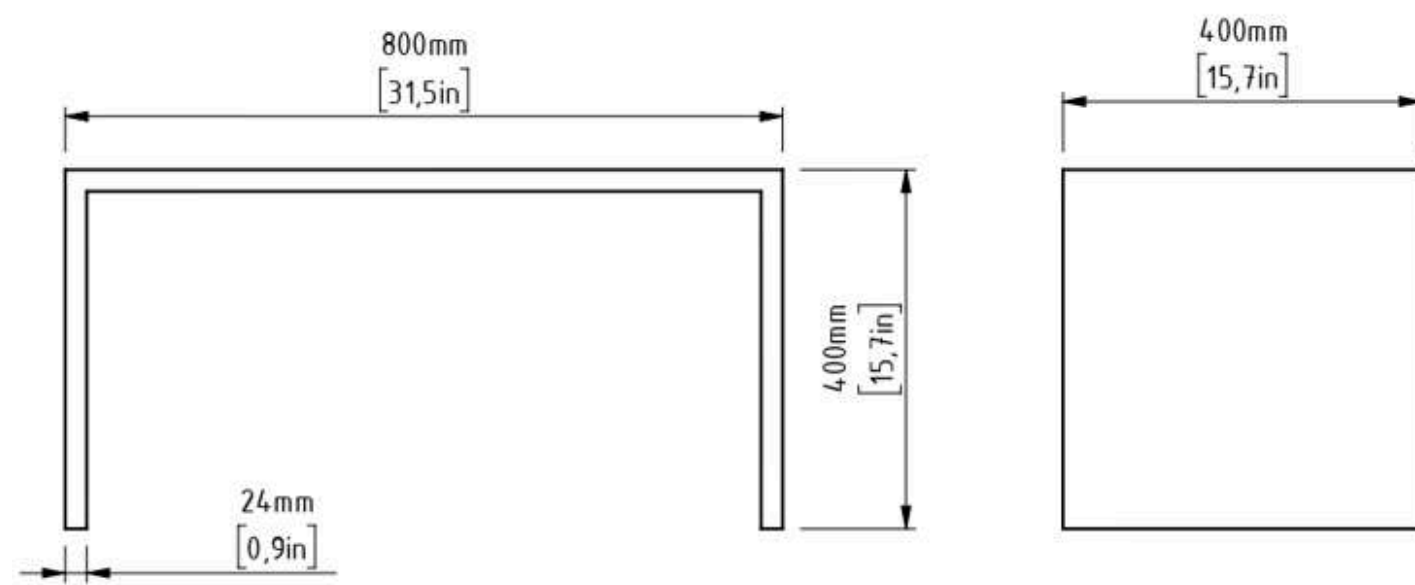
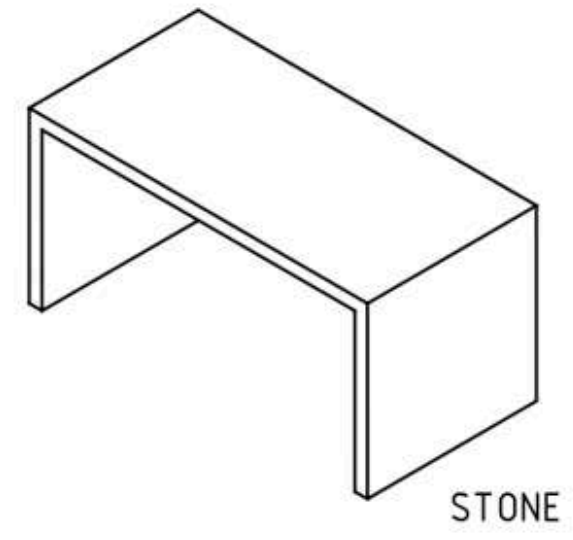
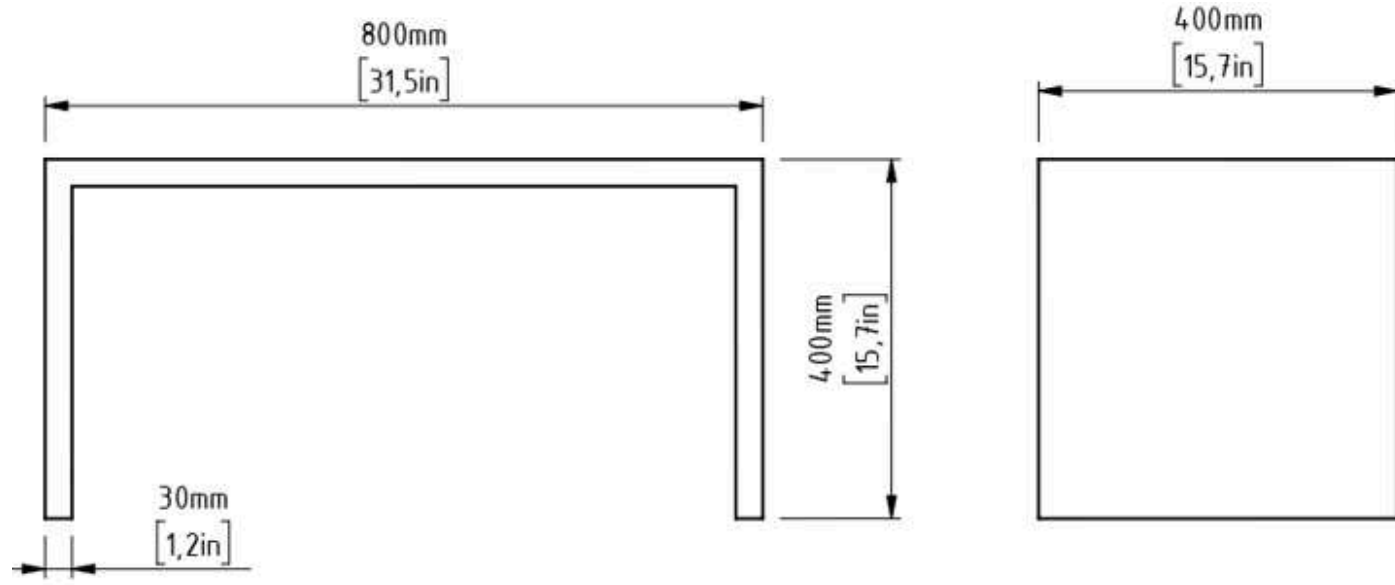

DIPINTO

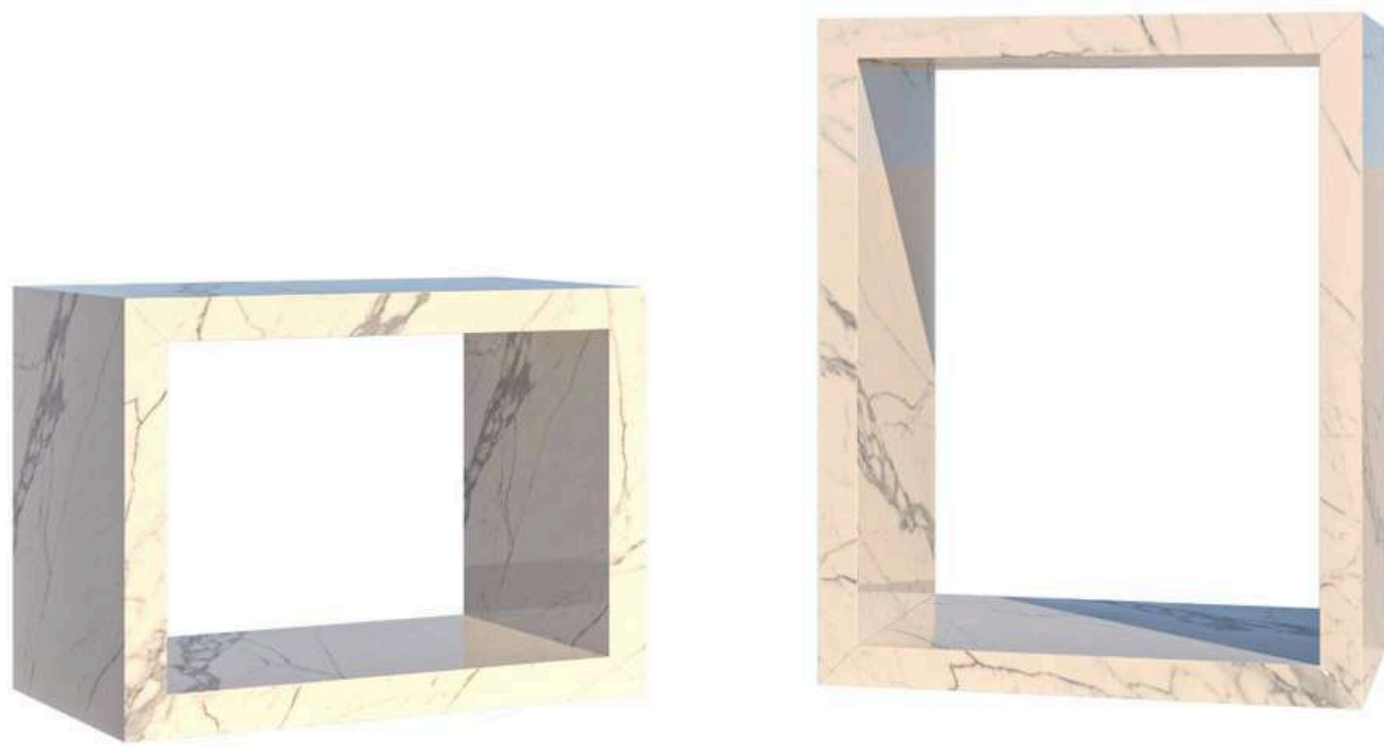

Product: Side table *Dipinto*
Processing: Statuario
Code: STDMS

Just like Ponte, Dipinto is a product that has both a practical and decorative role within the KORTA collections. Placed in a space as a single piece or a group of side tables for various purposes, it contributes to creation of dynamic ambiances.



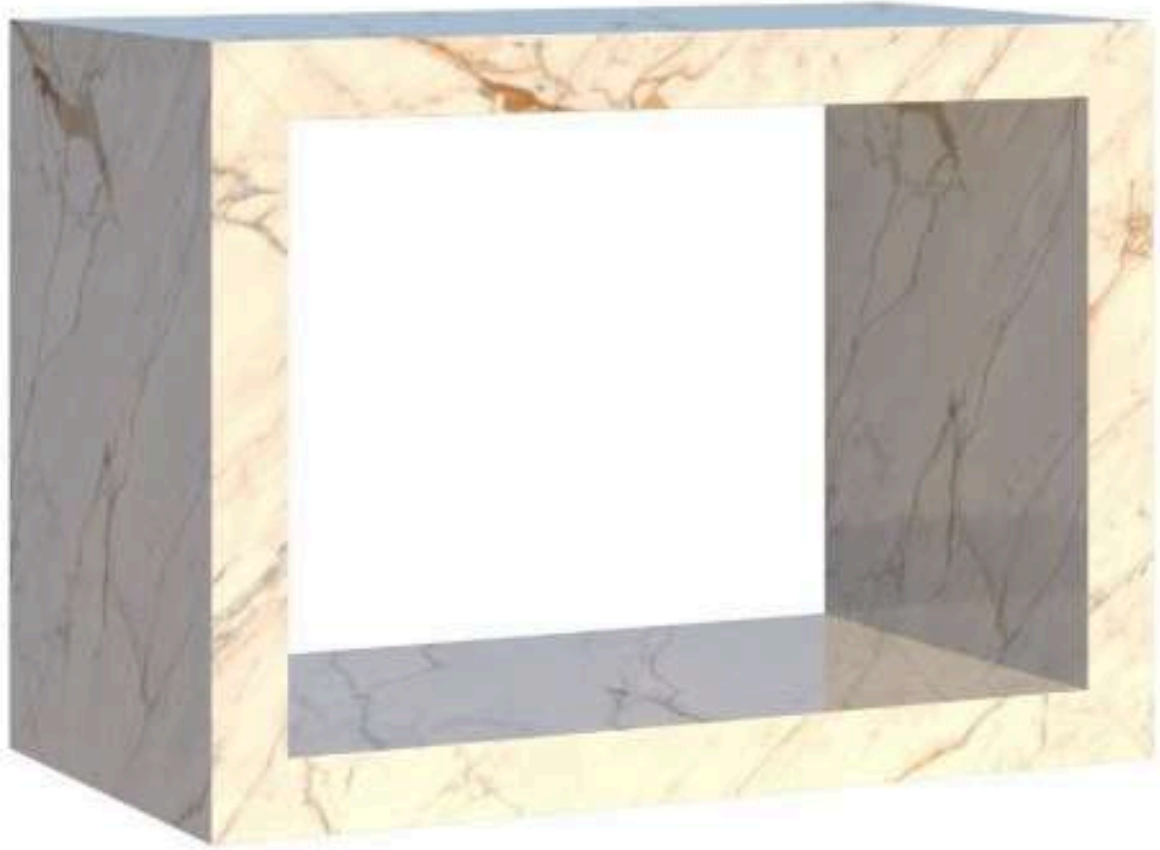

Product: Side table *Dipinto*
Material: Marazzi Golden White
Code: STDMGW

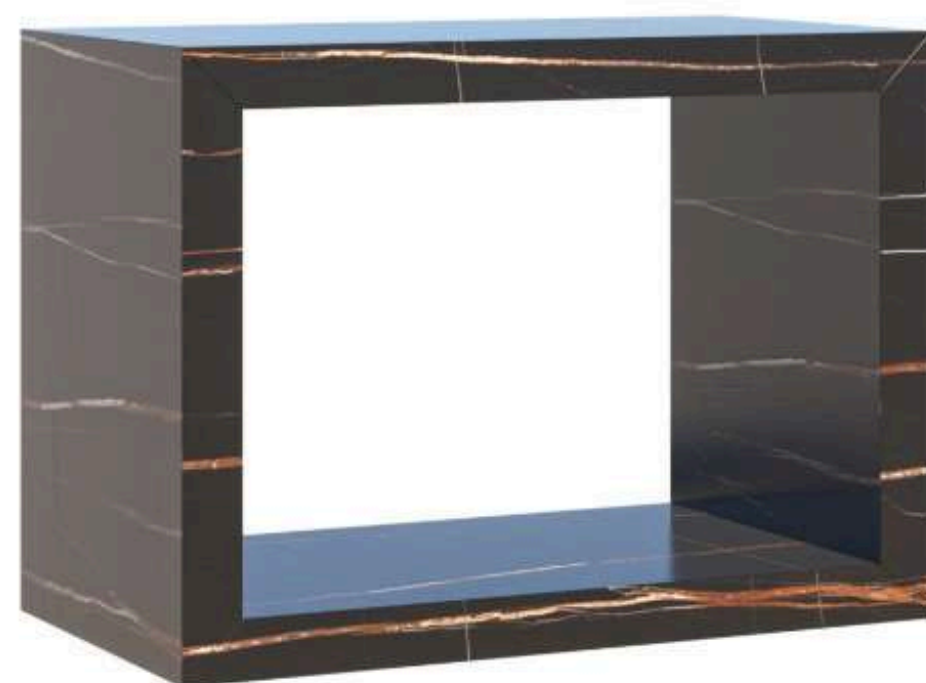

Product: Side table *Dipinto*
Material: Marazzi Sahara Noir
Code: STDMSN



PRODUCT DIMENSIONS

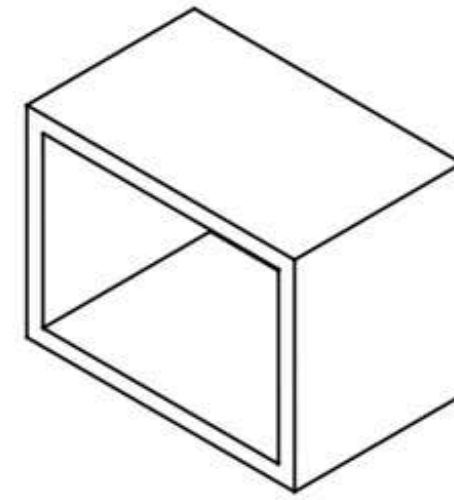
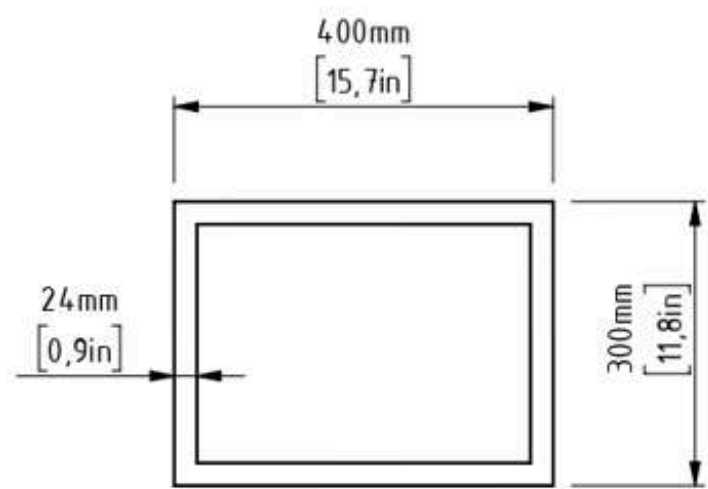

CERAMICS

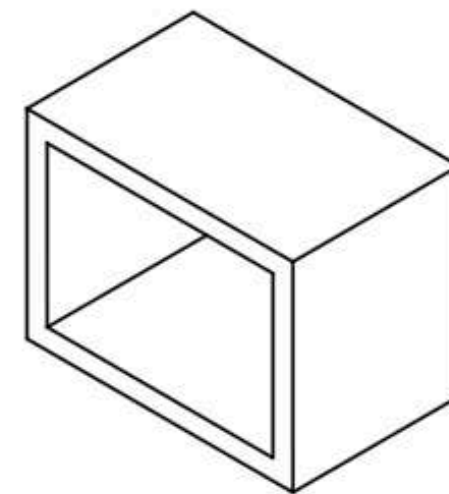
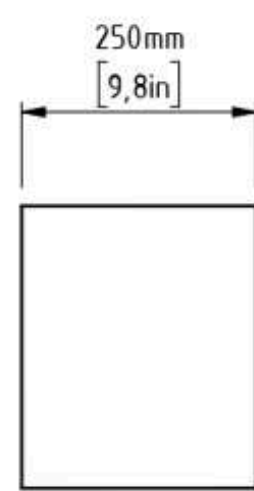
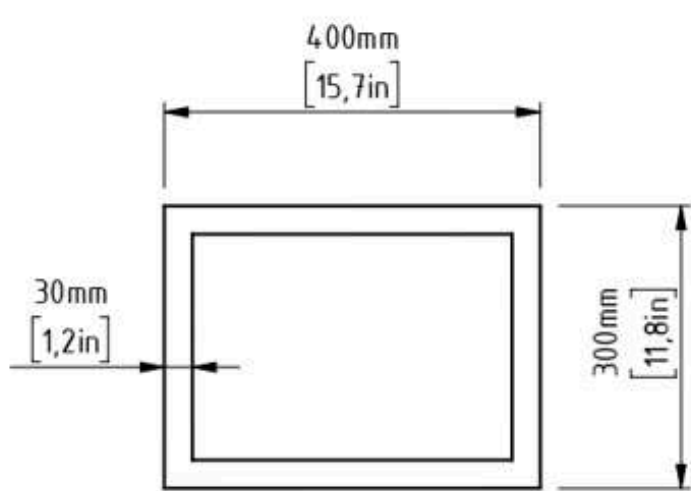

STONE



Product: Custom made Side table *Dipinto* / Coffee table *Ponte*
Material: Avorio - polished
Code: STDAP / CTPAP

CARA



Cara is a product line of planters available in two different shapes, perfectly matching the rest of the KORTA collections. As standalone elements, they are used to make a minimalist design statement.





Product: Planter *Cara*
Material: Kanfanar - polished
Code: PCIKP/PCOKP

PRODUCT DIMENSIONS

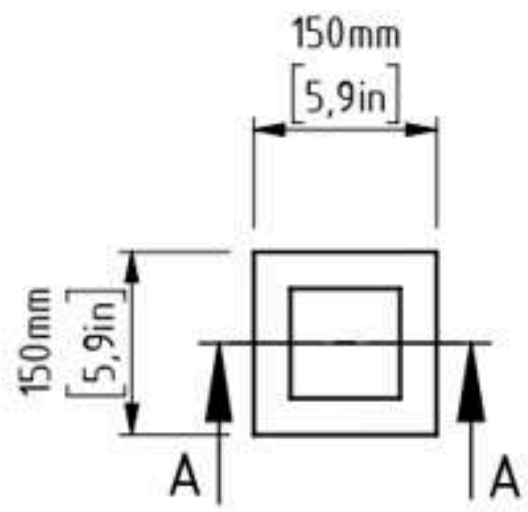

SECTION A-A

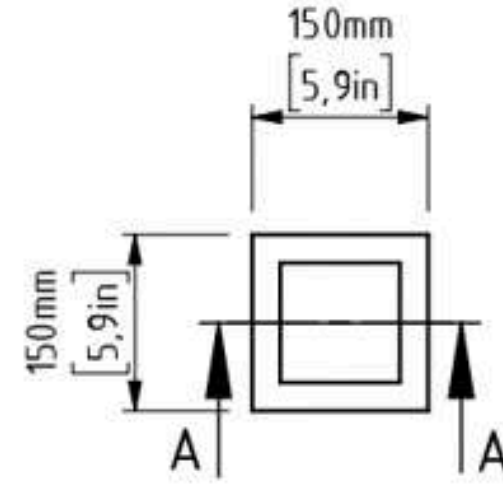

SECTION A-A

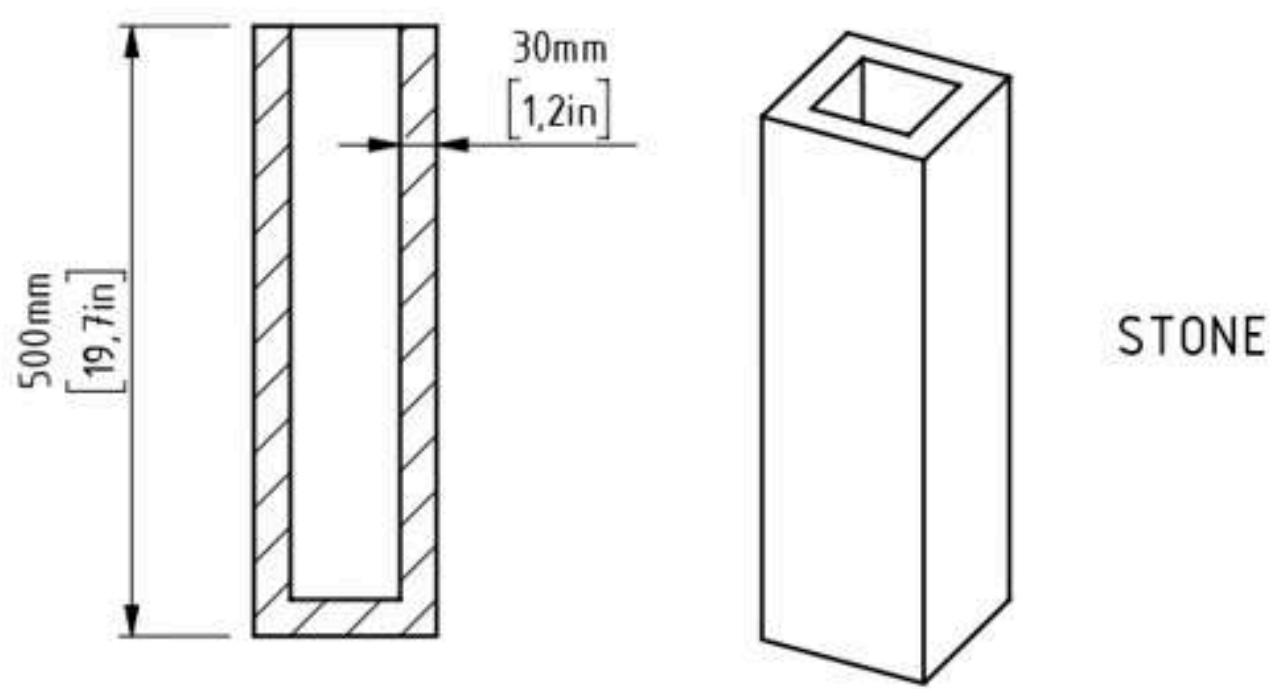

STONE

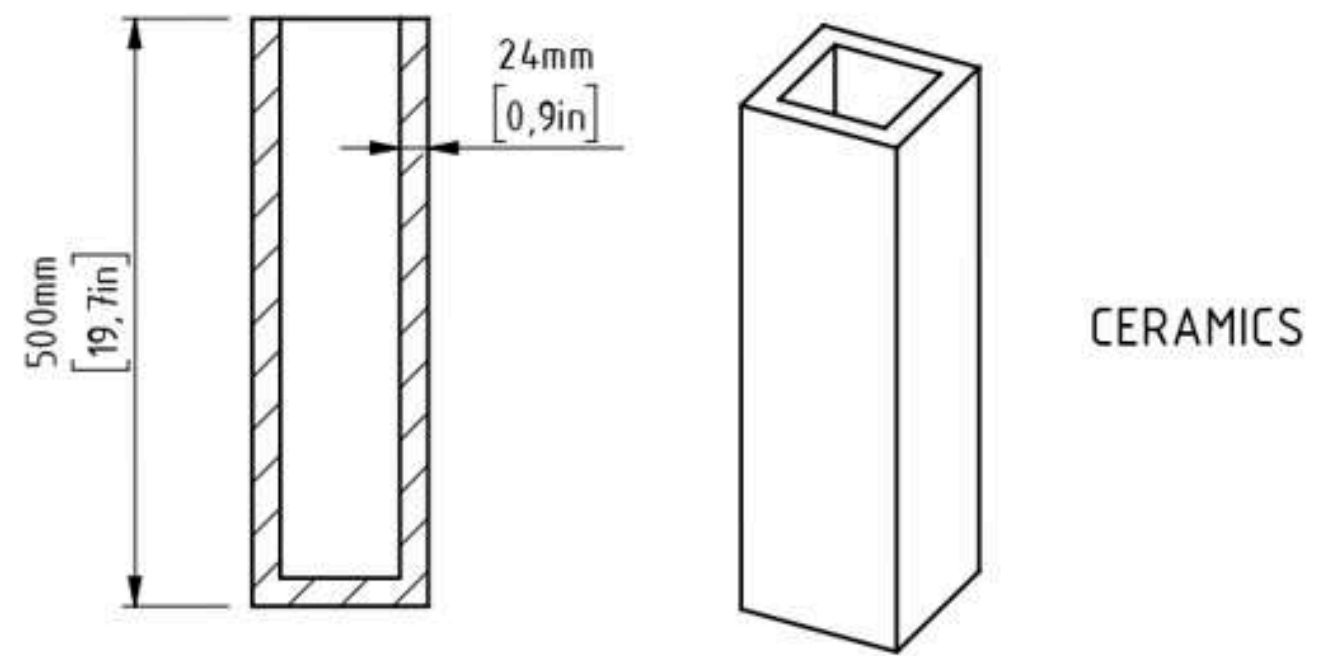

CERAMICS

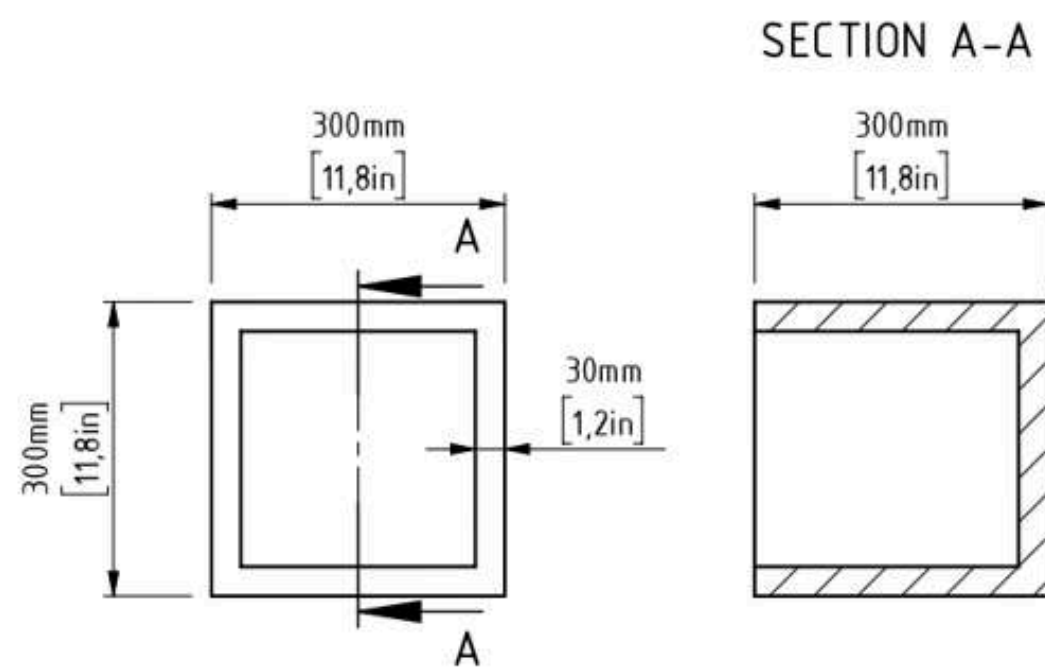

SECTION A-A

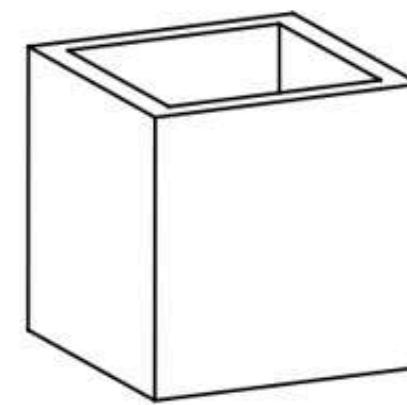
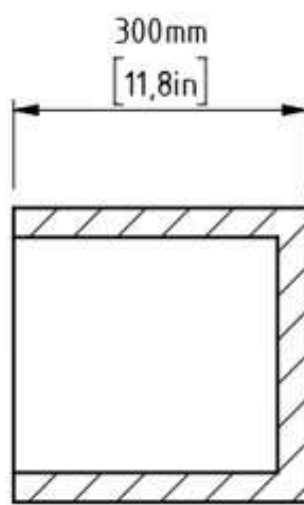

STONE

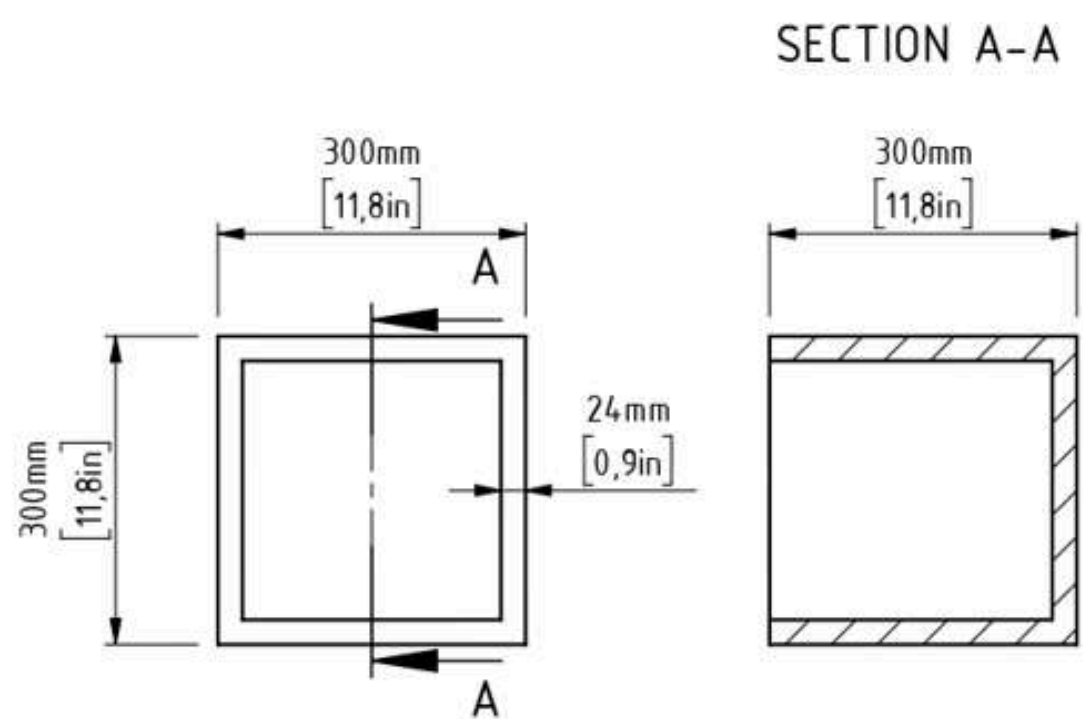

SECTION A-A

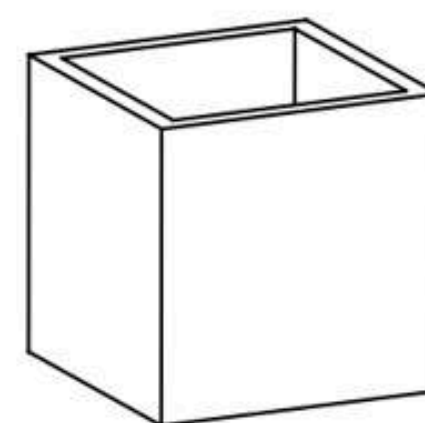
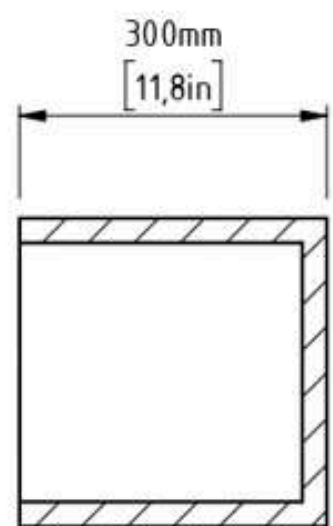

CERAMICS



DESIGNER'S HUB

Creating unique pieces, playing with materials, all with the aim of cultivating a timeless and harmoniously balanced design.

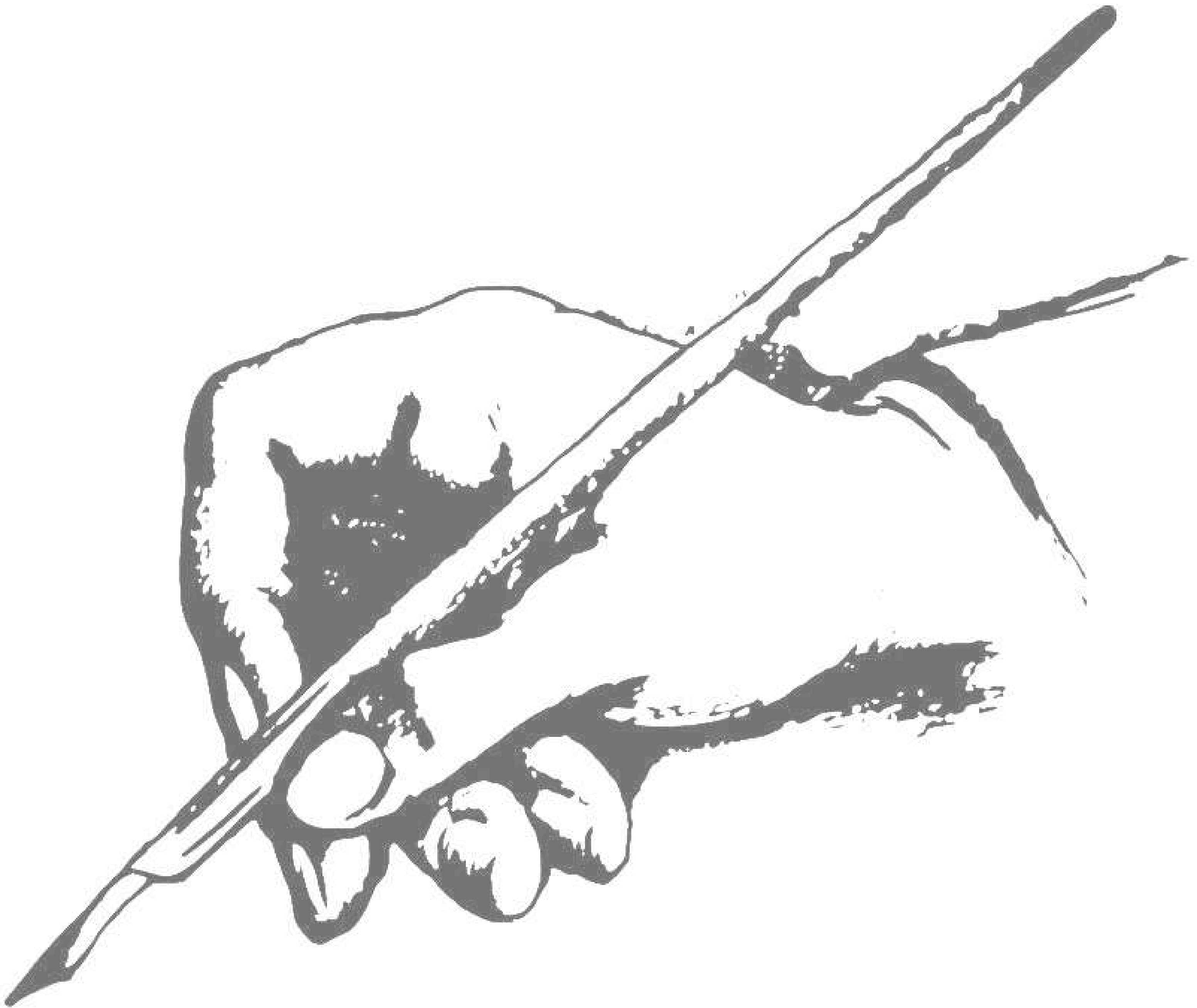

Unleash your creativity on the blank pages ahead as you join forces with us and our products, sketching your visionary projects that will pave the way for collaborative masterpieces. Capture your designs and share them with us by scanning the provided QR code, allowing us to embark on an artistic journey together, bringing your ideas to life in stunning harmony.





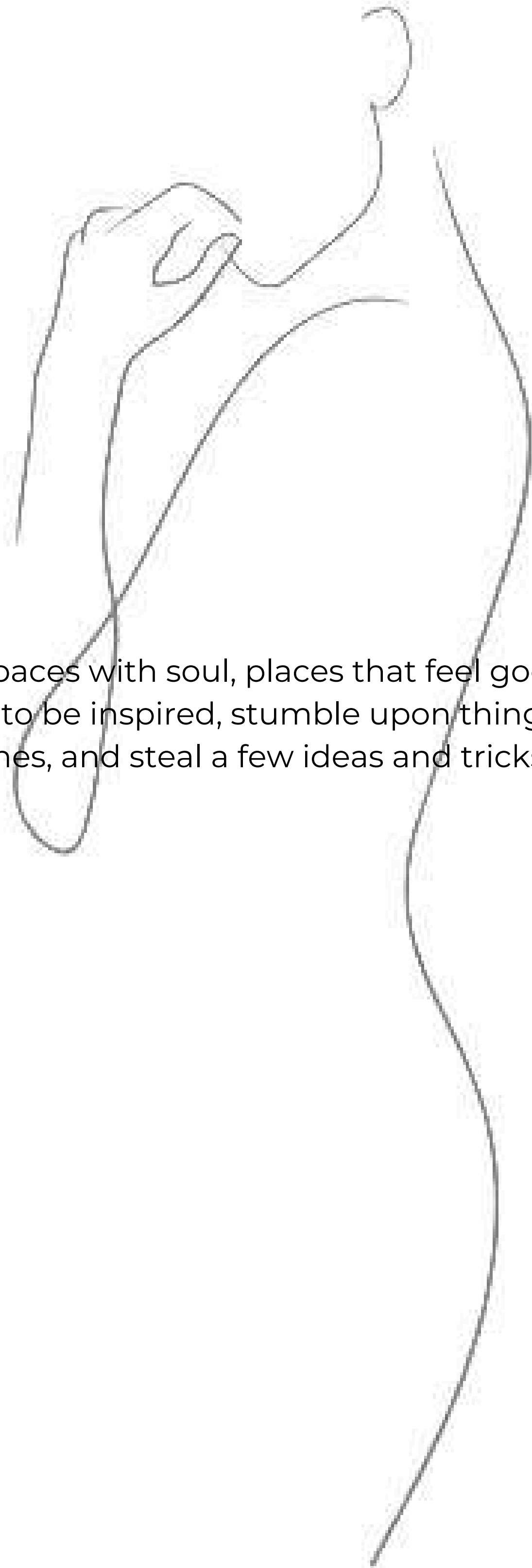

If you love to create spaces with soul, places that feel good to be in, let this be a place you can come to be inspired, stumble upon things that you love, crank some good tunes, and steal a few ideas and tricks along the way.

SPECIFICATION SHEETS

SPECIFICATION FEATURES - MARBELLA

Shower System

Consists of:

- 4 flexible knitted hose ½"
- 2-way mixing mechanism with faucet and handle designed by Mariner Rubinetterie
- Ecotech shower head by Mariner Rubinetterie which enables water savings of up to 50 %
- The informed Nattura S shower catalyst which has beneficial well being effects

This basic system is subject to change depending on chosen additions.

Water Pressure

- Min = 2 bar 29 PSI [lb/in²]
- Max = 4 bar 58 PSI [lb/in²]

Operating Voltage

- 24VDC

Maintenance

Regularly clean with soft cloth.

Usage

- Outdoor/Indoor

Delivery Box Dimensions & Weight

- 2533 x 1068 x 740 mm 100 x 42 x 29 in (Length x Height x Width)
- 33 kg / 73 lbs

Warranty

3 years warranty regarding defects in material and shower system.

IPX4 degree of protection

Foundation Type:

2 options for shower installation:

- Existing floor, floor covering and drain - installation using chemical dowel and anchor bolts
- On site foundation pouring with inlaid plate and threaded anchor rods

SPECIFICATION FEATURES - ODINO

Shower System

Consists of:

- 4 flexible knitted hose ½"
- 2-way mixing mechanism with faucet and handle designed by Mariner Rubinetterie
- Ecotech shower head by Mariner Rubinetterie which enables water savings of up to 50 %
- The informed Nattura S shower catalyst which has beneficial well being effects

This basic system is subject to change depending on chosen additions.

Water Pressure

- Min = 2 bar 29 PSI [lb/in²]
- Max = 4 bar 58 PSI [lb/in²]

Operating Voltage

- 24VDC

Maintenance

Regularly clean with soft cloth.

Usage

- Outdoor

Delivery Box Dimensions & Weight

- 2533 x 1600 x 710 mm 100 x 63 x 28 in (Length x Height x Width)
- 67 kg / 148 lbs

Warranty

3 years warranty regarding defects in material and shower system.

IPX4 degree of protection

Foundation Type:

Shower installation:

- Existing floor, floor covering and drain - installation using chemical dowel and anchor bolts,

SPECIFICATION FEATURES - MINIMO

Shower System

Consists of:

- 4 flexible knitted hose ½"
- 2-way mixing mechanism with faucet and handle designed by Mariner Rubinetterie
- Ecotech shower head by Mariner Rubinetterie which enables water savings of up to 50 %
- The informed Nattura S shower catalyst which has beneficial well being effects

This basic system is subject to change depending on chosen additions.

Water Pressure

- Min = 2 bar 29 PSI [lb/in²]
- Max = 4 bar 58 PSI [lb/in²]

Operating Voltage

- 24VDC

Maintenance

Regularly clean with soft cloth.

Usage

- Outdoor/Indoor

Delivery Box Dimensions & Weight

- 2533 x 800 x 300 mm 100 x 31 x 12 in (Length x Height x Width)
- 29 kg / 73 lbs

Warranty

3 years warranty regarding defects in material and shower system.

IPX4 degree of protection

Foundation Type:

2 options for shower installation:

- Existing floor, floor covering and drain - installation using chemical dowel and anchor bolts
- On site foundation pouring with inlaid plate and threaded anchor rods

SPECIFICATION FEATURES - MINNO

Shower System

Consists of:

- 4 flexible knitted hose ½"
- 2-way mixing mechanism with faucet and handle designed by Mariner Rubinetterie
- Ecotech shower head by Mariner Rubinetterie which enables water savings of up to 50 %
- The informed Nattura S shower catalyst which has beneficial well being effects

This basic system is subject to change depending on chosen additions.

Water Pressure

- Min = 2 bar 29 PSI [lb/in²]
- Max = 4 bar 58 PSI [lb/in²]

Operating Voltage

- 24VDC

Maintenance

Regularly clean with soft cloth.

Usage

- Outdoor/Indoor

Delivery Box Dimensions & Weight

- 2533 x 1600 x 410 mm 100 x 63 x 16 in (Length x Width x Height)
- 57 kg / 125 lbs

Warranty

3 years warranty regarding defects in material and shower system.

IPX4 degree of protection

Foundation Type:

2 options for shower installation:

- Existing floor, floor covering and drain - installation using chemical dowel and anchor bolts
- On site foundation pouring with inlaid plate and threaded anchor rods

AQUA ZONE
OUTDOOR SHOWERS

Product category	Name	Material	Sample	Code	Production time
Outdoor shower	Marbella	Kanfanar	Polished	MARKP	2-6 weeks
Outdoor shower	Marbella	Kanfanar	Bush hammered+brushed	MARKBHB	2-6 weeks
Outdoor shower	Marbella	Kanfanar	Sandblasted+brushed	MARKSB	2-6 weeks
Outdoor shower	Marbella	Kanfanar	Rigato	MARKR	2-6 weeks
Outdoor shower	Marbella	Kanfanar	Flamed+brushed	MARKFB	2-6 weeks
Outdoor shower	Marbella	Marazzi	Sahara Noir	MARMSN	4-8 weeks
Outdoor shower	Marbella	Marazzi	Statuario	MARMS	4-8 weeks
Outdoor shower	Marbella	Marazzi	Saint Laurent	MARMSL	4-8 weeks
Outdoor shower	Marbella	Marazzi	Golden White	MARMGW	4-8 weeks
Outdoor shower	Marbella	Marazzi	Grigio Carnico	MARMGC	4-8 weeks
Outdoor shower	Marbella	Marazzi	Corten	MARMC	4-8 weeks
Outdoor shower	Marbella	Marazzi	Rovere Francese	MARMRF	4-8 weeks
Outdoor shower	Marbella	Marazzi	Verde Aver	MARMVA	4-8 weeks
Outdoor shower	Marbella	Marazzi	Limestone Ivory	MARMLI	4-8 weeks
Outdoor shower	Marbella	Marazzi	Sodalite Blu	MARMSB	4-8 weeks
Outdoor shower	Odino	Kanfanar	Polished	ODKP	2-6 weeks
Outdoor shower	Odino	Kanfanar	Bush hammered+brushed	ODKBHB	2-6 weeks
Outdoor shower	Odino	Kanfanar	Sandblasted+brushed	ODKSB	2-6 weeks
Outdoor shower	Odino	Kanfanar	Rigato	ODKR	2-6 weeks
Outdoor shower	Odino	Kanfanar	Flamed+brushed	ODKFB	2-6 weeks
Outdoor shower	Odino	Marazzi	Sahara Noir	ODMSN	4-8 weeks
Outdoor shower	Odino	Marazzi	Statuario	ODMS	4-8 weeks
Outdoor shower	Odino	Marazzi	Saint Laurent	ODMSL	4-8 weeks
Outdoor shower	Odino	Marazzi	Golden White	ODMGW	4-8 weeks
Outdoor shower	Odino	Marazzi	Grigio Carnico	ODMGC	4-8 weeks
Outdoor shower	Odino	Marazzi	Corten	ODMC	4-8 weeks
Outdoor shower	Odino	Marazzi	Rovere Francese	ODMRF	4-8 weeks
Outdoor shower	Odino	Marazzi	Verde Aver	ODMVA	4-8 weeks
Outdoor shower	Odino	Marazzi	Limestone Ivory	ODMLI	4-8 weeks
Outdoor shower	Odino	Marazzi	Sodalite Blu	ODMSB	4-8 weeks
Outdoor shower	Minimo	Kanfanar	Polished	MINKP	2-6 weeks
Outdoor shower	Minimo	Kanfanar	Bush hammered+brushed	MINKBHB	2-6 weeks
Outdoor shower	Minimo	Kanfanar	Sandblasted+brushed	MINKSB	2-6 weeks
Outdoor shower	Minimo	Kanfanar	Rigato	MINKR	2-6 weeks
Outdoor shower	Minimo	Kanfanar	Flamed+brushed	MINKFB	2-6 weeks
Outdoor shower	Minimo	Marazzi	Sahara Noir	MINMSN	4-8 weeks
Outdoor shower	Minimo	Marazzi	Statuario	MINMS	4-8 weeks
Outdoor shower	Minimo	Marazzi	Saint Laurent	MINMSL	4-8 weeks
Outdoor shower	Minimo	Marazzi	Golden White	MINMGW	4-8 weeks
Outdoor shower	Minimo	Marazzi	Grigio Carnico	MINMGC	4-8 weeks
Outdoor shower	Minimo	Marazzi	Corten	MINMC	4-8 weeks
Outdoor shower	Minimo	Marazzi	Rovere Francese	MINMRF	4-8 weeks
Outdoor shower	Minimo	Marazzi	Verde Aver	MINMVA	4-8 weeks
Outdoor shower	Minimo	Marazzi	Limestone Ivory	MINMLI	4-8 weeks
Outdoor shower	Minimo	Marazzi	Sodalite Blu	MINMSB	4-8 weeks
Outdoor shower	Minno	Kanfanar	Polished	MINNKP	2-6 weeks
Outdoor shower	Minno	Kanfanar	Bush hammered+brushed	MINNKBHB	2-6 weeks
Outdoor shower	Minno	Kanfanar	Sandblasted+brushed	MINNKSB	2-6 weeks
Outdoor shower	Minno	Kanfanar	Rigato	MINNKR	2-6 weeks
Outdoor shower	Minno	Kanfanar	Flamed+brushed	MINNKFB	2-6 weeks
Outdoor shower	Minno	Marazzi	Sahara Noir	MINNMSN	4-8 weeks
Outdoor shower	Minno	Marazzi	Statuario	MINNMS	4-8 weeks
Outdoor shower	Minno	Marazzi	Saint Laurent	MINNMSL	4-8 weeks
Outdoor shower	Minno	Marazzi	Golden White	MINNMGW	4-8 weeks
Outdoor shower	Minno	Marazzi	Grigio Carnico	MINNMGC	4-8 weeks
Outdoor shower	Minno	Marazzi	Corten	MINNMC	4-8 weeks
Outdoor shower	Minno	Marazzi	Rovere Francese	MINNMRF	4-8 weeks
Outdoor shower	Minno	Marazzi	Verde Aver	MINNMVA	4-8 weeks
Outdoor shower	Minno	Marazzi	Limestone Ivory	MINNMLI	4-8 weeks
Outdoor shower	Minno	Marazzi	Sodalite Blu	MINNMSB	4-8 weeks

ADDITIONS

Name	Applicable for	Material	Processing	Code	Production time
Motion Sensor	all showers	Stainless Steel	Brushed	MS	extra 1 week
Heating Cable	all showers	PVC	N/A	HC	extra 2 weeks
Logo Engraving	all showers	N/A	N/A	LE	extra 1 week
Water Tank	only Marazzi material	Stainless Steel	Polished	WT	extra 2 weeks
Lighting	Marbella and Odino	Stainless Steel	Brushed	L	extra 2 weeks
Floor Decking	Odino and Minno	Thermal Ash	N/A	FD	extra 2 weeks
XL Showerhead	Odino	Stainless Steel	Brushed	XLS	extra 5 weeks
Hand Shower	all showers	Stainless Steel	Brushed	HS	extra 3 weeks

KADA

Product Category	Name	Material	Sample	Code	Production time
Outdoor Bathtub	Latia	Kanfanar	Honed/Brushed	OBKLA	8-12 weeks
Outdoor Bathtub	Enea	Kanfanar	Honed/Brushed	OBKE	8-12 weeks
Outdoor Bathtub	Ania	Kanfanar	Honed/Brushed	OBKA	8-12 weeks
Outdoor Bathtub	Gaia	Kanfanar	Honed/Brushed	OBKG	8-12 weeks
Outdoor Bathtub	Luce	Kanfanar	Honed/Brushed	OBKLU	8-12 weeks
Outdoor Bathtub	Mena	Kanfanar	Honed/Brushed	OBKM	8-12 weeks

FUOQO ZONE

GARDENZIO

Product category	Model	Name	Back Type	Code	Production time
Outdoor kitchen	Robusta	Compatto 75	Flat back	ROKC75	10-12 weeks
Outdoor kitchen	Robusta	Medio 75	Flat back	ROKM75	10-12 weeks
Outdoor kitchen	Robusta	Grande 75	Flat back	ROKG75	10-12 weeks
Outdoor kitchen	Elegante	Compatto 80	Wall adjacent	ROKEC80	10-12 weeks
Outdoor kitchen	Elegante	Compatto 90	Island	ROKEC90	10-12 weeks
Outdoor kitchen	Elegante	Medio 80	Wall adjacent	ROKEM80	10-12 weeks
Outdoor kitchen	Elegante	Medio 90	Island	ROKE M90	10-12 weeks
Outdoor kitchen	Elegante	Medio 120	Island	ROKEM120	10-12 weeks
Outdoor kitchen	Elegante	Grande 80	Wall adjacent	ROKEG80	10-12 weeks
Outdoor kitchen	Elegante	Grande 90	Island	ROKEG90	10-12 weeks
Outdoor kitchen	Elegante	Grande 120	Island	ROKEG120	10-12 weeks

OPTIONS

Frame colour	Top and side options	Door inlay options	Appliance options
Black - CIE	Kanfanar Polished - SP	European Oak - DUB	Big Green Egg L - BGEL
Anthracite - ANT	Nero Assoluto - NA	Brazil Nut - IPE	Indu+Gazzgrill - IG
Grey - SIV	Marazzi - MA	Siberian Larch - SIB	Caso BBQ Cooler - CHLD
Mocha - MOK		Laminate - HPL	Rubbish Bins - RB
Latte - LAT			

KAMIN

Product category	Name	Material	Processing	Code	Production time
Outdoor fire pit	Kamin	Kanfanar	Polished	KAMKP	8-10 weeks
Outdoor fire pit	Kamin	Kanfanar	Bush hammered+brushed	KAMKBHB	8-10 weeks
Outdoor fire pit	Kamin	Kanfanar	Sandblasted+brushed	KAMKSB	8-10 weeks
Outdoor fire pit	Kamin	Kanfanar	Rigato	KAMKR	8-10 weeks
Outdoor fire pit	Kamin	Kanfanar	Flamed+brushed	KAMKFB	8-10 weeks

ARIA ZONE

Product category	Name	Material	Processing	Code	Production time
Coffee Table	Ponte L/XL	Kanfanar	Polished	CTPLKP/CTPXLKP	2-6 weeks
Coffee Table	Ponte L/XL	Kanfanar	Bush hammered+brushed	CTPLKBHB/CTPXLKBHB	2-6 weeks
Coffee Table	Ponte L/XL	Kanfanar	Sandblasted+brushed	CTPLKSB/CTPXLKSB	2-6 weeks
Coffee Table	Ponte L/XL	Kanfanar	Rigato	CTPLKR/CTPXLKR	2-6 weeks
Coffee Table	Ponte L/XL	Kanfanar	Flamed+brushed	CTPLKFB/CTPXLKFB	2-6 weeks
Coffee Table	Ponte L/XL	Marazzi	Sahara Noir	CTPLMSN/CTPXLMSN	4-8 weeks
Coffee Table	Ponte L/XL	Marazzi	Statuario	CTPLMS/CTPXLMS	4-8 weeks
Coffee Table	Ponte L/XL	Marazzi	Saint Laurent	CTPLMSL/CTPXLMSL	4-8 weeks
Coffee Table	Ponte L/XL	Marazzi	Golden White	CTPLMGW/CTPXLMGW	4-8 weeks
Coffee Table	Ponte L/XL	Marazzi	Grigio Carnico	CTPLMGC/CTPXLMGC	4-8 weeks
Coffee Table	Ponte L/XL	Marazzi	Corten	CTPLMC/CTPXLMC	4-8 weeks
Coffee Table	Ponte L/XL	Marazzi	Rovere Francese	CTPLMRF/CTPXLRF	4-8 weeks
Coffee Table	Ponte L/XL	Marazzi	Verde Aver	CTPLMVA/CTPXLMVA	4-8 weeks
Coffee Table	Ponte L/XL	Marazzi	Limestone Ivory	CTPLMLI/CTPXLMLI	4-8 weeks
Coffee Table	Ponte L/XL	Marazzi	Sodalite Blu	CTPLMSB/CTPXLMSB	4-8 weeks
Side Table	Dipinto	Kanfanar	Polished	STDKP	2-6 weeks
Side Table	Dipinto	Kanfanar	Bush hammered+brushed	STDKBHB	2-6 weeks
Side Table	Dipinto	Kanfanar	Sandblasted+brushed	STDKSB	2-6 weeks
Side Table	Dipinto	Kanfanar	Rigato	STDKR	2-6 weeks
Side Table	Dipinto	Kanfanar	Flamed+brushed	STDKFB	2-6 weeks
Side Table	Dipinto	Marazzi	Sahara Noir	STDMSN	4-8 weeks
Side Table	Dipinto	Marazzi	Statuario	STDMS	4-8 weeks
Side Table	Dipinto	Marazzi	Saint Laurent	STDMSL	4-8 weeks
Side Table	Dipinto	Marazzi	Golden White	STDMGW	4-8 weeks
Side Table	Dipinto	Marazzi	Grigio Carnico	STDMGC	4-8 weeks
Side Table	Dipinto	Marazzi	Corten	STDMC	4-8 weeks
Side Table	Dipinto	Marazzi	Rovere Francese	STDMRF	4-8 weeks
Side Table	Dipinto	Marazzi	Verde Aver	STDMVA	4-8 weeks
Side Table	Dipinto	Marazzi	Limestone Ivory	STDMLI	4-8 weeks
Side Table	Dipinto	Marazzi	Sodalite Blu	STDSB	4-8 weeks
Planter	Cara I/O	Kanfanar	Polished	PCIKP/PCOKP	2-6 weeks
Planter	Cara I/O	Kanfanar	Bush hammered+brushed	PCIKBHB/PCOKBHB	2-6 weeks
Planter	Cara I/O	Kanfanar	Sandblasted+brushed	PCIKSB/PCOKSB	2-6 weeks
Planter	Cara I/O	Kanfanar	Rigato	PCIKR/PCOKR	2-6 weeks
Planter	Cara I/O	Kanfanar	Flamed+brushed	PCIKFB/PCOKFB	2-6 weeks
Planter	Cara I/O	Marazzi	Sahara Noir	PCIMSN/PCOMSN	4-8 weeks
Planter	Cara I/O	Marazzi	Statuario	PCIMS/PCOMS	4-8 weeks
Planter	Cara I/O	Marazzi	Saint Laurent	PCIMSL/PCOMSL	4-8 weeks
Planter	Cara I/O	Marazzi	Golden White	PCIMGW/PCOMGW	4-8 weeks
Planter	Cara I/O	Marazzi	Grigio Carnico	PCIMGC/PCOMGC	4-8 weeks
Planter	Cara I/O	Marazzi	Corten	PCIMC/PCOMC	4-8 weeks
Planter	Cara I/O	Marazzi	Rovere Francese	PCIMRF/PCOMRF	4-8 weeks
Planter	Cara I/O	Marazzi	Verde Aver	PCIMVA/PCOMVA	4-8 weeks
Planter	Cara I/O	Marazzi	Limestone Ivory	PCIMLI/PCOMLI	4-8 weeks
Planter	Cara I/O	Marazzi	Sodalite Blu	PCIMSB/PCOMSB	4-8 weeks

CERTIFICATES



Certificate of Conformity

Number: C211-0050/21 Project file: C20212197

Product: Shower with led light

Type reference: MARBELLA

Trademark: INFINITY LUXURY

Applicant: Infinity Luxury d.o.o.
Stancija Pataj 52A, Bertoši, HR-52000 Pazin, Croatia

Manufacturer: Infinity Luxury d.o.o.
Stancija Pataj 52A, Bertoši, HR-52000 Pazin, Croatia

Place of manufacture: Infinity Luxury d.o.o.
Stancija Pataj 52A, Bertoši, HR-52000 Pazin, Croatia

This certificate is granted subject to the SIQ's rules on product certification. SIQ certifies the conformity of the products with the requirements of the listed standards.

Ratings: 220-240 V-; IPX4; 5 W; class II

Standard: EN 60335-2-105:2005 + A1:2008 + A11:2010 + A2:2020
EN 60335 1:2012 + A11:2014 + A13:2017 + A1:2019 + A14:2019 + A2:2019

Test report: T211-0902/21 (2021-09-30)

Remarks: This certificate shall apply to the products identical to the tested sample and shall remain valid for the period of 3 years until 2024-10-29 or until the validity date of the listed standards, whichever occurs earlier.

Date: 2021-10-29 Authorized signature: Bojan Pečavar



Only integral publication of this certificate is allowed. This certificate may only be reproduced in its entirety and without any changes. On request SIQ will give information about the validity of the certificate.

SIQ Ljubljana, Mašera-Spasičeva ulica 10, SI-1000 Ljubljana, Slovenia
T +386 1 4778 100, F +386 1 4778 444, info@siq.si, www.siq.si

World Intellectual Property Office
34, chemin des Colombettes
P.O. Box 18
CH - 1211 Geneva
Switzerland

HAGUE AGREEMENT CONCERNING THE INTERNATIONAL REGISTRATION OF INDUSTRIAL DESIGNS

- STATEMENT OF GRANT OF PROTECTION -

Rule 18bis(1) of the Common Regulations

I. Office sending the statement:	The Norwegian Industrial Property Office PO Box 4863 Nydalen, N-0422 Oslo website: www.patentstyret.no	Telephone + 47 22 38 73 00 Telefax + 47 22 38 73 01 e-mail: post@patentstyret.no
II. Number of the international registration:	DM/213763	
III. <input checked="" type="checkbox"/> Protection is (to be) granted for all the industrial designs <input type="checkbox"/> Protection is (to be) granted for the following industrial designs: (followed by design numbers)		
IV. Date on which the international registration produced or shall produce the effect as a grant of protection under the applicable law (in respect of the industrial designs indicated under item III):	2021.03.31	
V. Date of the statement:	2021.06.06	
VI. Signature or official seal of the Office sending the statement:	THE NORWEGIAN INDUSTRIAL PROPERTY OFFICE Sabrina Fregosi	



World Intellectual Property Office
34, chemin des Colombettes
P.O. Box 18
CH - 1211 Geneva
Switzerland

Date: 06/06/2021

The product "MARBELLA" outdoor shower, made by the company Infinity Luxury d.o.o., has the industrial design protected. It is protected under the code: DM/213763, by the World Intellectual Property Organization or the European Union Intellectual Property Office (World Intellectual Property Organization - WIPO or the European Union Intellectual Property Office - EUIPO).



DECLARATION OF PERFORMANCE No 0008

- Unique identification code of the product-type: **SUPERFLEX**
- Intended use/es:
Improved reaction resin adhesive for all internal and external tiling.
- Manufacturer: **Kerakoll S.p.A Via dell'Artigianato, 9 - 41049 Sassuolo (MO) Italia**
- System/s of AVCP:
System 3
System 3 for reaction to fire
- Harmonised standard: **EN 12004:2007 + A1:2012**
Notified body/ies: **Modena Centro Prove No. 1599**
Istituto Giordano No. 0407
- Declared performance/s:

Essential characteristics	Performance
Reaction to fire	Class B-s1,d0/B1-s1
Bond strength as: initial shear adhesion strength	≥ 2,0 N/mm²
Durability for: shear adhesion strength after thermal shock shear adhesion strength after water immersion	≥ 2,0 N/mm² ≥ 2,0 N/mm²
Release of dangerous substances	See SDS

The performance of the product identified above is in conformity with the set of declared performance/s. This declaration of performance is issued, in accordance with Regulation (EU) No 305/2011, under the sole responsibility of the manufacturer identified above.

Signed for and on behalf of the manufacturer by: **Romano Sghedoni (legal representative)**
At Sassuolo, on 07/05/2020



www.kerakoll.com

KERAKOLL Spa - Soggetta a direzione e coordinamento di Fin-Firel Spa
via dell'Artigianato, 9 - 41049 Sassuolo (MO) Italia - Tel +39 0536 816 511 - Fax +39 0536 816 581 - e-mail: info@kerakoll.com
Rea MO n. 231812 - Reg. Imp. / Cod. Fisc. / P. Iva IT 01174510360 - Cap. Soc. € 2.000.000,00 i.v.

EN.IT.0008.004



18 KAMEN d.d. PAZIN Trg Slobode 2 52000 PAZIN, CROATIA	
Natural stone with commercial name „PLANO“ EN 1469:2015 Natural stone products – Slabs for cladding	
Flexural strength -average -standard deviation -lower expectation	11,4 MPa 1,1 MPa 9,3 MPa
Water absorption at atmospheric pressure A_w	1,18 (%)
Apparent density ρ_a Open porosity p_v	2587 kg/m ³ 4,01 %
Frost resistance (Change of flexural strength after 56 freezing cycles) -average value before frost-thawing changes -average value after frost-thawing changes	11,4 MPa 10,4 MPa
Reaction to fire	Class A1
Direct airborne sound insulation -average value	2587 kg/m ³
Thermal resistance -average value	2587 kg/m ³
Breaking load at dowel hole - slab 3cm thickness – Φ 10mm, d1=25mm	1960 N
Petrographic denomination	limestone
Dangerous substances	none

KAMEN d.d.
Trg slobode 2
52000 Pazin
Hrvatska

t. +385 (0) 52 624 242
f. +385 (0) 52 624 441
e. info@kamen.hr

www.kamen.hr

Place and date: "Kamen d.d.", Pazin, Croatia
Pazin, 2022. Aleksandra Krebel Kostrenčić, director

KAMEN, d.o.o. obilježava na proizvodima i obradivim materijalima. Trgovnički sud u Pazinu, broj udjela 15/15/2020-2, MBS: 342120166, MB: 3334747, OIB: 20927912716. Izdava: 2022.02.20. KAMEN d.d. PAZIN, Trg Slobode 2, 52000 Pazin, Hrvatska. Kontakt: t. +385 (0) 52 624 242, f. +385 (0) 52 624 441, e. info@kamen.hr. DNPV-GL: 00 9000. DNPV-GL: 00 9000.



DECLARATION OF PERFORMANCE
NR. 22/21

KAMEN d.d.
Trg slobode 2
52000 Pazin
Hrvatska

t. +385 (0) 52 624 242
f. +385 (0) 52 624 441
e. info@kamen.hr

www.kamen.hr

- Unique identification of the product: Natural stone with commercial name
KANFANAR
- Use: Natural stone products – Slabs for cladding
- Name and address of the manufacturer: KAMEN d.d. PAZIN
Trg Slobode 2, 52000 PAZIN, HR
- Conformity evaluation system: 4
- Used standards: EN 1469:2015 Natural stone products – Slabs for cladding
- In accordance with conformity evaluation system 4, manufacturer performs:
 - determination of the product-type on the basis of type testing
 - factory production control
- Declared performances:

TECHNICAL PROPERTIES	TEST RESULTS	TEST METHOD
Flexural strength -average value -standard deviation -lower expectation	9,4 MPa 1,4 MPa 6,9 MPa	EN 12372:2007-02
Water absorption at atmospheric pressure A_w	0,68 (%)	EN 13755:2008-08
Apparent density ρ_a Open porosity p_v	2640 kg/m ³ 2,10 %	EN 1936:2007-02
Frost resistance (Change of flexural strength after 56 freezing cycles) -average value before frost-thawing changes -average value after frost-thawing changes	9,4 MPa 6,9 MPa	EN 12371:2001
Reaction to fire	Class A1	EN 13501-1:2000
Direct airborne sound insulation -average value	2640 kg/m ³	EN 1936:2007
Thermal resistance -average value	2640 kg/m ³	EN 1936:2007
Breaking load at dowel hole - slab 3cm thickness – Φ 10mm, d1=10mm - slab 4cm thickness – Φ 10mm, d1=15mm	1750 N 3000 N	EN 13364:2002-03
Petrographic denomination	limestone	EN 12407:2007
Dangerous substances	none	/

8. The performances of the product, specified in points 1 and 2, are in accordance with the declared performances in point 7. This Declaration of Performance is published under the sole responsibility of the manufacturer identified in point 3.

KAMEN, d.o.o. obilježava na proizvodima i obradivim materijalima. Trgovnički sud u Pazinu, broj udjela 15/15/2020-2, MBS: 342120166, MB: 3334747, OIB: 20927912716. Izdava: 2022.02.20. KAMEN d.d. PAZIN, Trg Slobode 2, 52000 Pazin, Hrvatska. Kontakt: t. +385 (0) 52 624 242, f. +385 (0) 52 624 441, e. info@kamen.hr. DNPV-GL: 00 9000. DNPV-GL: 00 9000.



19 KAMEN d.d. PAZIN Trg Slobode 2 52000 PAZIN, CROATIA	
Natural stone with commercial name „KANFANAR“ 22/19 EN 1469:2015 Natural stone products – Slabs for cladding	
Flexural strength -average -standard deviation -lower expectation	9,4 MPa 1,4 MPa 6,9 MPa
Water absorption at atmospheric pressure A_w	0,68 (%)
Apparent density ρ_a Open porosity p_v	2640 kg/m ³ 2,10 %
Frost resistance (Change of flexural strength after 56 freezing cycles) -average value before frost-thawing changes -average value after frost-thawing changes	9,4 MPa 6,9 MPa
Reaction to fire	Class A1
Direct airborne sound insulation -average value	2640 kg/m ³
Thermal resistance -average value	2640 kg/m ³
Breaking load at dowel hole - slab 3cm thickness – Φ 10mm, d1=10mm - slab 4cm thickness – Φ 10mm, d1=15mm	1750 N 3000 N
Petrographic denomination	limestone
Dangerous substances	none

KAMEN d.d.
Trg slobode 2
52000 Pazin
Hrvatska

t. +385 (0) 52 624 242
f. +385 (0) 52 624 441
e. info@kamen.hr

www.kamen.hr

Place and date: "Kamen d.d.", Pazin, Croatia
Pazin, 02.02.2021. Aleksandra Krebel Kostrenčić, director

KAMEN, d.o.o. obilježava na proizvodima i obradivim materijalima. Trgovnički sud u Pazinu, broj udjela 15/15/2020-2, MBS: 342120166, MB: 3334747, OIB: 20927912716. Izdava: 2022.02.20. KAMEN d.d. PAZIN, Trg Slobode 2, 52000 Pazin, Hrvatska. Kontakt: t. +385 (0) 52 624 242, f. +385 (0) 52 624 441, e. info@kamen.hr. DNPV-GL: 00 9000. DNPV-GL: 00 9000.



Safety data sheet
According to 1907/2006/EC (REACH), 2015/830/EU
EF919A EPOLIT FIX 919 A DIAMOND TIX



SECTION 1: IDENTIFICATION OF THE SUBSTANCE/MIXTURE AND OF THE COMPANY/UNDERTAKING

1.1 Product identifier: EF919A EPOLIT FIX 919 A DIAMOND TIX
1.2 Relevant identified uses of the substance or mixture and uses advised against:
Relevant uses: High performance coatings. For professional user/industrial user only.
Uses advised against: All uses not specified in this section or in section 7.3
1.3 Details of the supplier of the safety data sheet:
SIGMADIAMANT
Pol Industrial Suppl 8, M5 b1, nave 17
12550 Almazora - Castellón - España
T: +34 964 562 713
WWW.SIGMADIAMANT.COM
1.4 Emergency telephone number: +34 962725676

SECTION 2: HAZARDS IDENTIFICATION

2.1 Classification of the substance or mixture:
CLP Regulation (EC) No 1272/2008:
Classification of this product has been carried out in accordance with CLP Regulation (EC) No 1272/2008.
Aquatic Chronic 2; Hazardous to the aquatic environment, long-term hazard, Category 2, H411
Eye Irrit. 2; Eye irritation, Category 2, H319
Skin Irrit. 2; Skin irritation, Category 2, H315
Skin Sens. 1; Sensitisation, skin, Category 1, H317
2.2 Label elements:
CLP Regulation (EC) No 1272/2008:
Warning

Hazard statements:
Aquatic Chronic 2; H411 - Toxic to aquatic life with long lasting effects
Eye Irrit. 2; H319 - Causes serious eye irritation
Skin Irrit. 2; H315 - Causes skin irritation
Skin Sens. 1; H317 - May cause an allergic skin reaction
Precautionary statements:
P261: Avoid breathing dust/fume/gas/mist/vapours/spray
P254: Wash thoroughly after handling
P273: Avoid release to the environment
P280: Wear protective gloves/protective clothing/eye protection/face protection
P302+P352: IF ON SKIN: Wash with plenty of water
P305+P351+P338: IF IN EYES: Rinse cautiously with water for several minutes. Remove contact lenses, if present and easy to do. Continue rinsing
P391: Collect spillage
P501: Dispose of contents/container in accordance with regulations on hazardous waste or packaging and packaging waste respectively
Supplementary information:
EUH205: Contains epoxy constituents. May produce an allergic reaction
Substances that contribute to the classification
reaction products: bisphenol-A-(epichlorhydrin) (MW < 700); Bisphenol-F-epichlorhydrin/epoxy resins; Oxirane, mono[(C12-14-alkyloxy)methyl] derivs
2.3 Other hazards:
Product fails to meet PBT/vPvB criteria

SECTION 3: COMPOSITION/INFORMATION ON INGREDIENTS

OTHER MATERIALS

made upon request

MARBLE - GRANITE

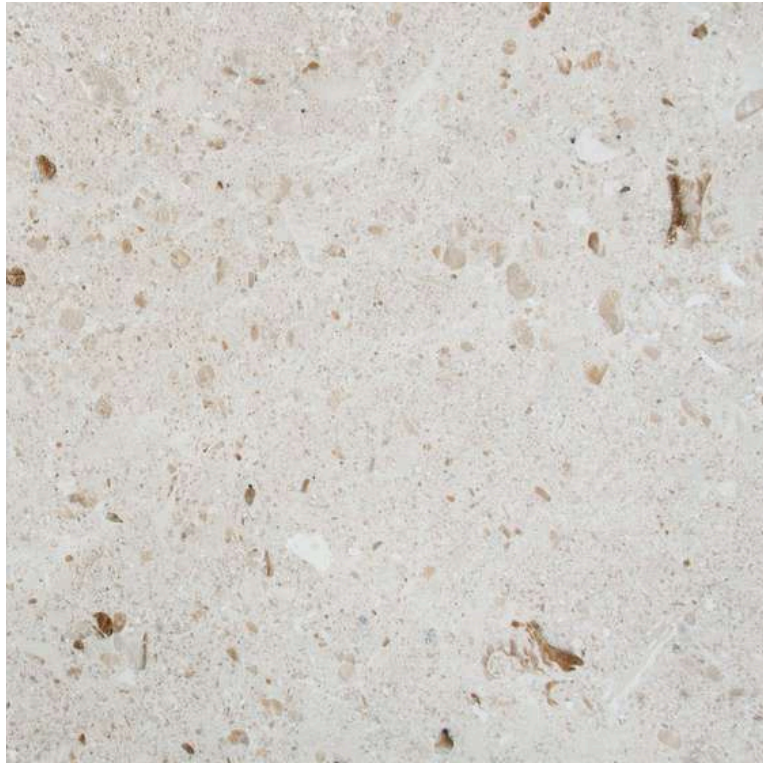

Plano Polished

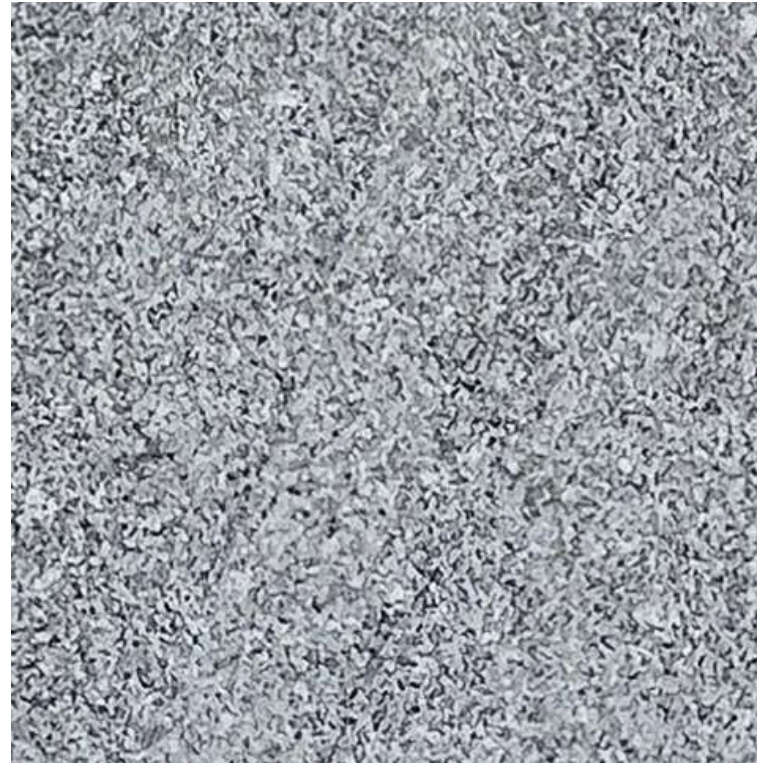

Rosa Beta



Grigio Ardesio



Giallo Siena

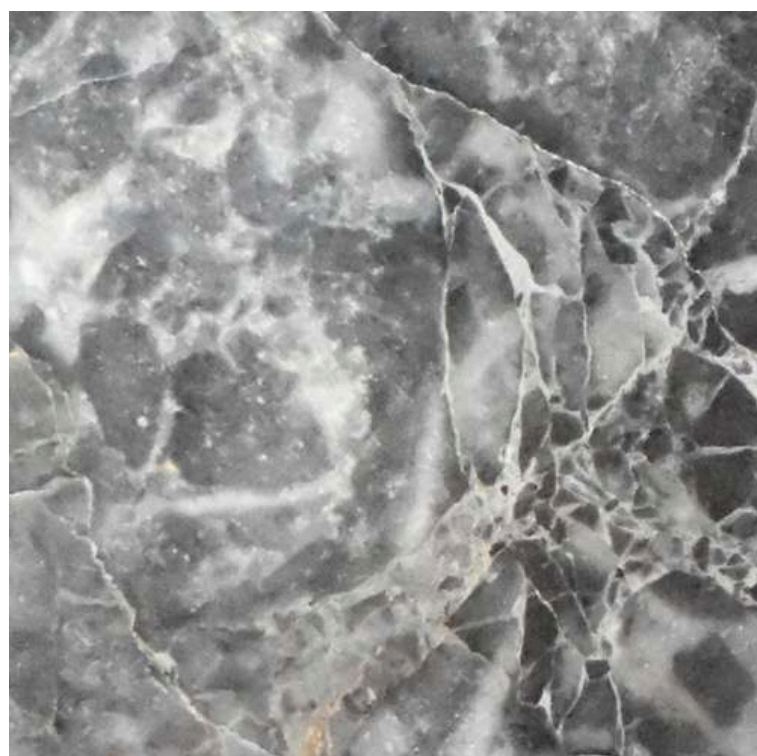

Moncervetto

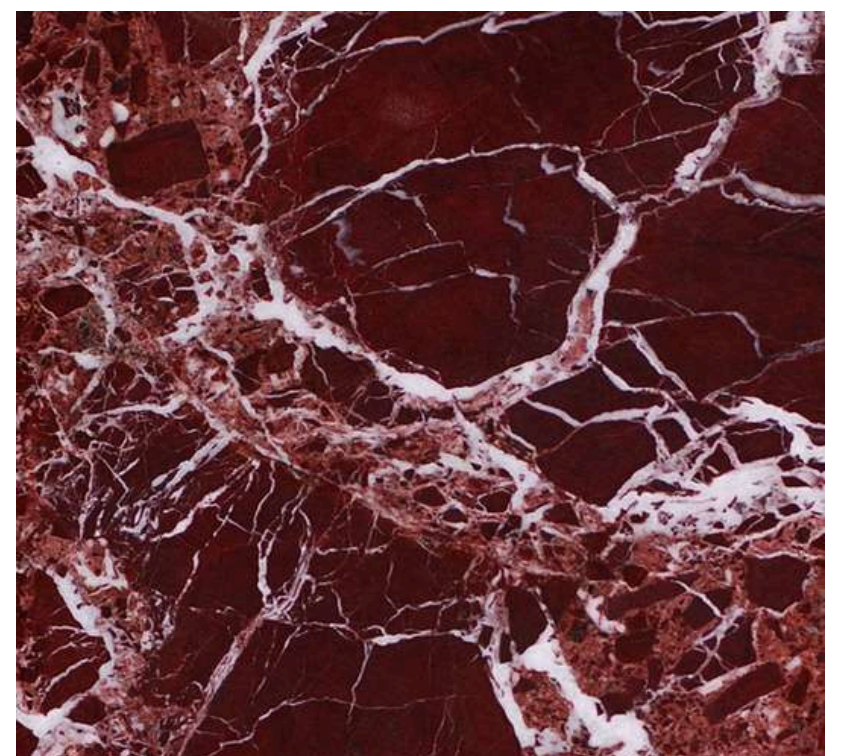

Rosso Levanto



Portoro

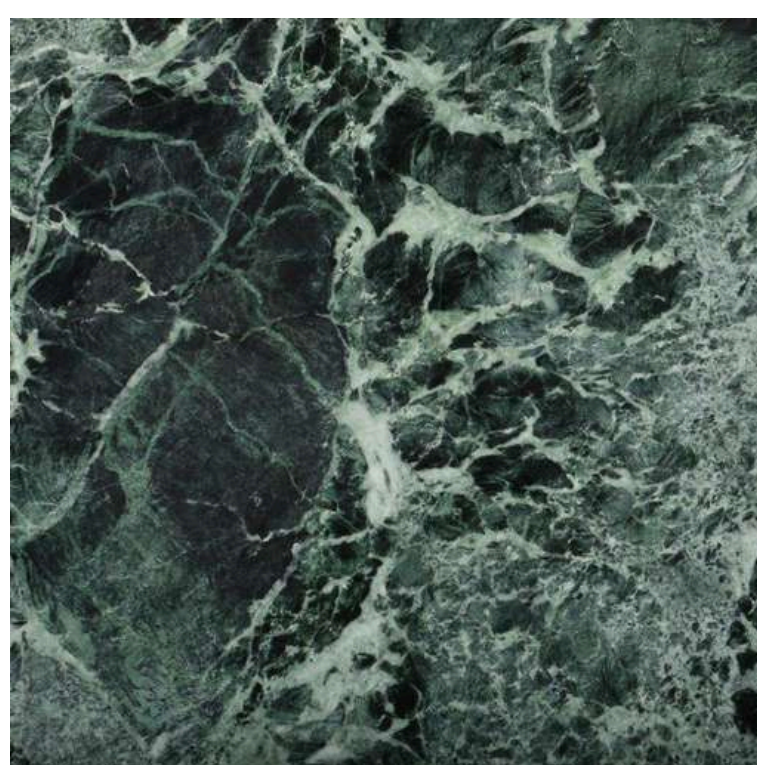

Verde Alpi

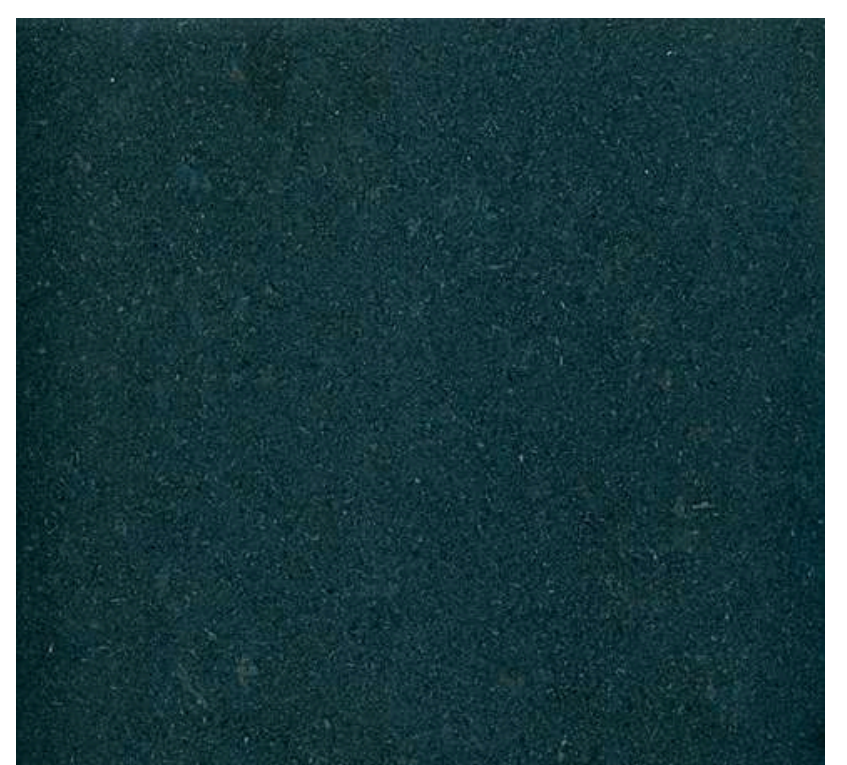

Nero Assoluto

PORCELAIN SLABS -



Brera Grey



Bianco Arni



Capraia



Ceppo di Gré



Imperiale



Elegant Black



Limestone Sand



Terrazzo Grey



Verde Borgogna



Travertino Classico



Quartzo Bluegray

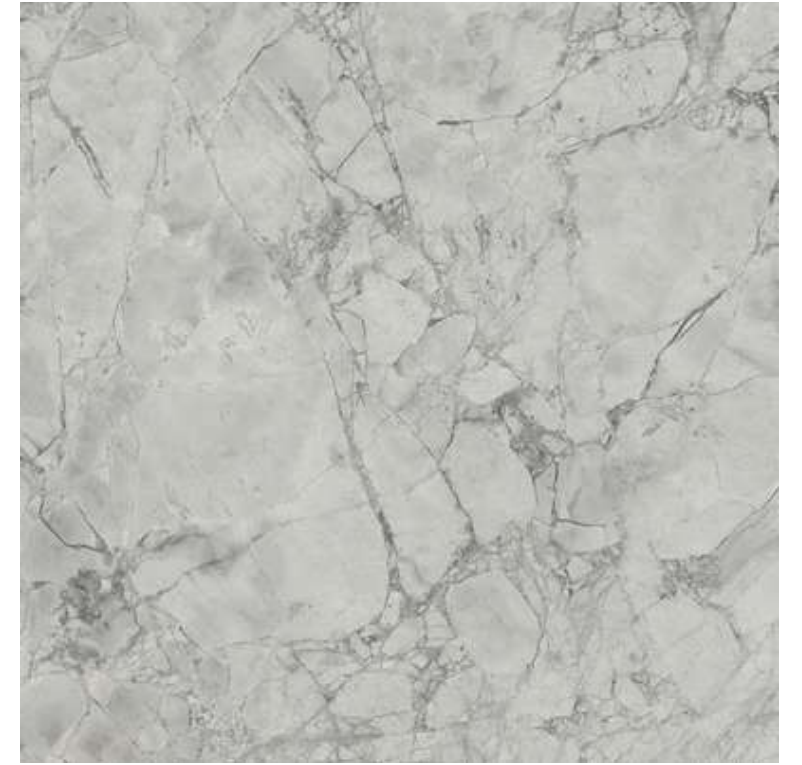

Superwhite



Onice Nero



Fior di Pesco Carnico

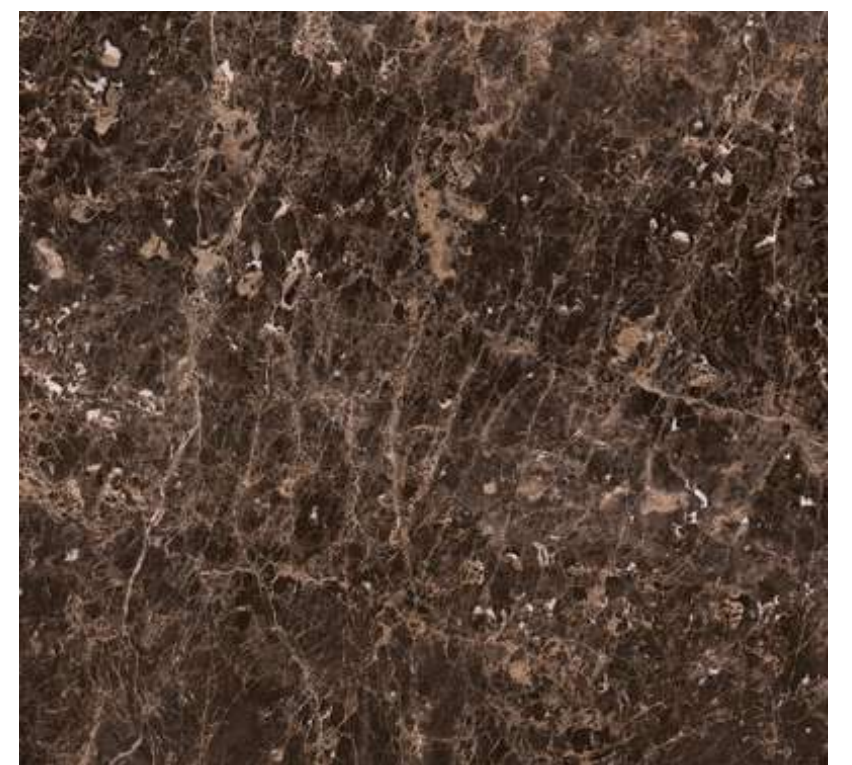

Emperador



Calacatta Vena Vecchia



Calacatta Extra



Calacatta Black



This is how it all started..

MADE IN ISTRIA, LOVED WORLDWIDE.



Europe: Spain, Germany, Austria, Italy, Croatia, Montenegro, The Netherlands, Belgium, Poland, Czech Republic, Greece, France, Malta, Slovakia, Portugal

USA: Florida, New York, Massachusetts, New Jersey

World: Middle East, Australia, New Zealand, China, Caribbean, Colombia

...And this is where we are now.

INFINITY LUXURY D.O.O.

+385 52 743 776

info@kortadesign.com

www.kortadesign.com